



CATALOGO GENERALE
GENERAL CATALOGUE



indice

2	Un pensiero un'azienda	70	Porte a due ante
4	Evoluzione	78	Qualità e Sicurezza
6	Forti si nasce	86	I rivestimenti
13	Le serrature	92	Rivestimenti esterni
24	Un'eccellenza del design italiano E-WAY porta blindata traslante scorrevole	146	Rivestimenti interni
38	Il primato della qualità IMMENZA porta blindata con cerniere a scomparsa	182	Trasparenze
48	Porte ad un anta	191	Le maniglie
		207	Dati tecnici
		221	I materiali

UN PENSIERO, UN'AZIENDA ONE THOUGHT, ONE BUSINESS

Dal 1979 produco porte blindate e spesso ho avuto la sensazione che pochi sapessero cogliere quanta dedizione, ricerca dell'innovazione, rispetto per l'uomo e per l'ambiente possono accompagnare la realizzazione di un manufatto che apparentemente potrebbe considerarsi 'scontato'.

Nella mia attività non mi sono mai accontentato di risultati convenzionali, dettati dalla semplice economia di produzione: ma ho voluto indagare tutte le soluzioni, per scegliere le migliori senza condizionamenti. Questo ha riguardato i processi di lavorazione mirati al rispetto del personale, l'impiego di materiali ad alta impronta tecnologica, la costruzione di un prodotto che consente il recupero differenziato di ogni componente, una volta dismesso.

Il tema etico è una costante di molti progetti che ho intrapreso; e già diversi anni orsono, (ancora oggi non ci sono proposte analoghe sul mercato) ho concepito la porta blindata accessibile ad anziani e a disabili, anticipando i principi del *design for all*. Scelte che di certo hanno influito sul posizionamento delle mie porte in fascia elevata, limitandone i grandi numeri, ma che ne hanno fatto un prodotto 'vero', di qualità autentica.

I have been producing armoured doors since 1979 and I have often felt that few people realise how much dedication, research of innovation, respect for mankind and the environment may go into the creation of a product, which apparently could be 'taken for granted'.

In my business I've never settled for conventional results dictated by simple production economics: but I have tried to investigate all solutions to find the best free from any unnecessary constraints.

This covered the processes aimed at the respect of staff, the use of highly technological materials, the creation of a product that allows you to recycle each component, when it is no longer required.

The subject of ethics is a hallmark of many projects that I have undertaken; and several years ago (even today there are similar proposals in the market) I designed the armoured door which is accessible to elderly and disabled people, anticipating the principles of the design for all. Choices that have certainly affected the high-end positioning of my doors, limiting the big numbers, but that have made them 'genuine' products, of authentic quality.

Franco Paolucci
Fondatore e amministratore
EFFEPI[®]

"A farin ben...".

Ho voluto citare una poesia dialettale della mia terra
(la Romagna a cui sono molto legato).

"Faremo bene...", è il pensiero che mi guida quando
intraprendo un nuovo progetto.

I wanted to quote a poem in dialect of my home land
(Romagna of which I am very fond of).

"We will do well...".

This is the thought to guide me when I start a new project.

A FARIN BEN?

A farin ben

a circhè ad fe

li robie fatie ben?

Forse le mei

ad fè sno finta.

I se a frighen ma tut.

Anche ma nun.

FAREMO BENE?

Faremo bene

a cercare di fare bene?

Forse è meglio

fare solo finta.

Così freghiamo tutti.

Anche noi stessi.

V. Cecchini



Anno di fondazione dell'azienda
con la semplice dicitura 'Effepi'

1979

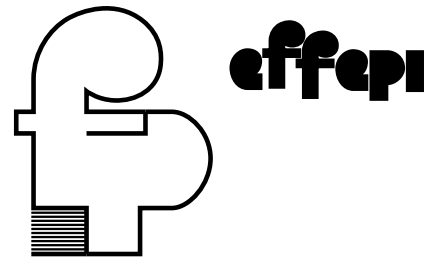

Effepi è sponsor del Concorso
internazionale di architettura
'La casa più bella del mondo'

1991



Primo restyling del logo aziendale
con la nuova dicitura 'Il blindato Effepi'

1995



'Polifemo'
Nomination al Grandesign etico
International Award 2008

2006



Riconoscimento 'ADI Index' alla linea
di blindati E-Way
Partecipazione al XXIII Compasso d'Oro

2012



Restyling grafico del marchio con richiamo al 'Made in Italy' e nuova dicitura 'Effepi Security Doors'

2016



Evoluzione del marchio, evoluzione d'impresa

MAJOR FIBERGLASS FIBERCARBON **THE FUTURE**

Il futuro non si ferma, come non si arrestano la ricerca e l'innovazione.

Nata come barriera di protezione, nel tempo abbiamo affinato la qualità della porta blindata con nuove caratteristiche tecniche: la tenuta all'acqua e al vento, la riduzione della trasmittanza termica, l'abbattimento acustico, l'incremento delle soluzioni estetiche. Oggi stiamo compiendo un decisivo scatto in avanti con la linea '**Major**', la prima e unica porta blindata realizzata con materiali compositi in fibra di vetro e fibra di carbonio.

Frutto della ricerca Effepi®, questa porta si presenta con elevate performance in linea con le nuove richieste di contenimento dei consumi energetici e, contestualmente, con una ottima resistenza all'effrazione.

We cannot stop the future, and we cannot stop research and innovation.

Originally created as a protective barrier, over time we have refined the quality of armoured doors with new technical features: water and wind proofing, heat transfer reduction, noise reduction, increase in aesthetic solutions.

Today we are taking a decisive step forward with the '**Major**' line, the first and only armoured door made of glass fibre and carbon fibre composite materials.

The result of Effepi® research, this door comes with high performance in line with the new demands for the reduction of energy consumption and, at the same time, with excellent resistance to burglary.

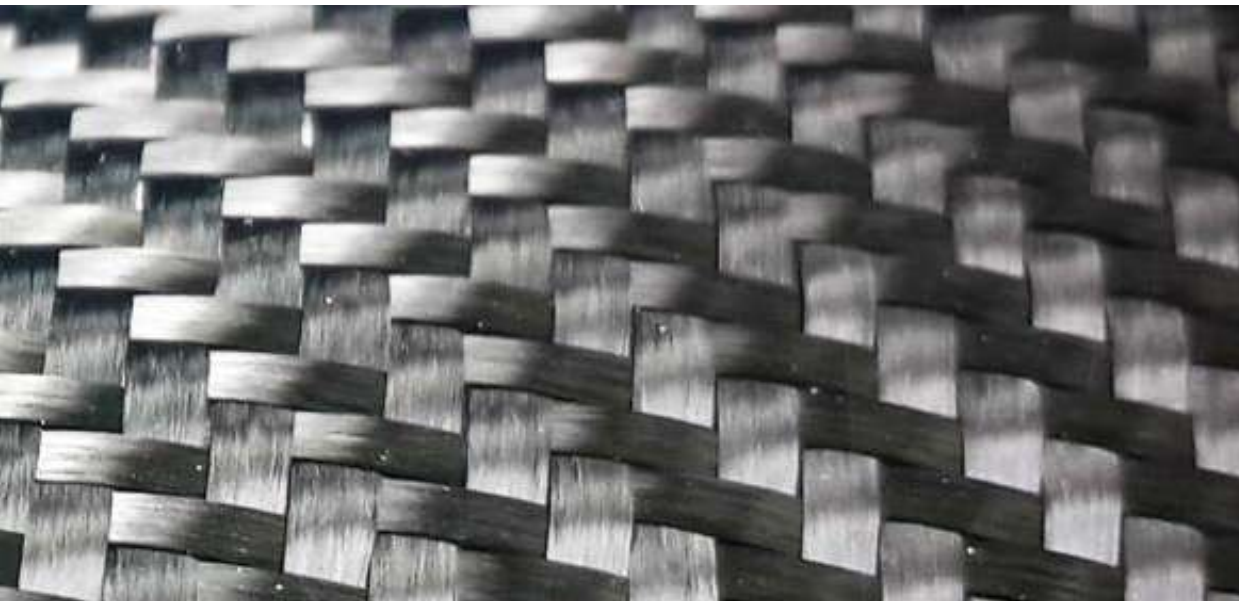

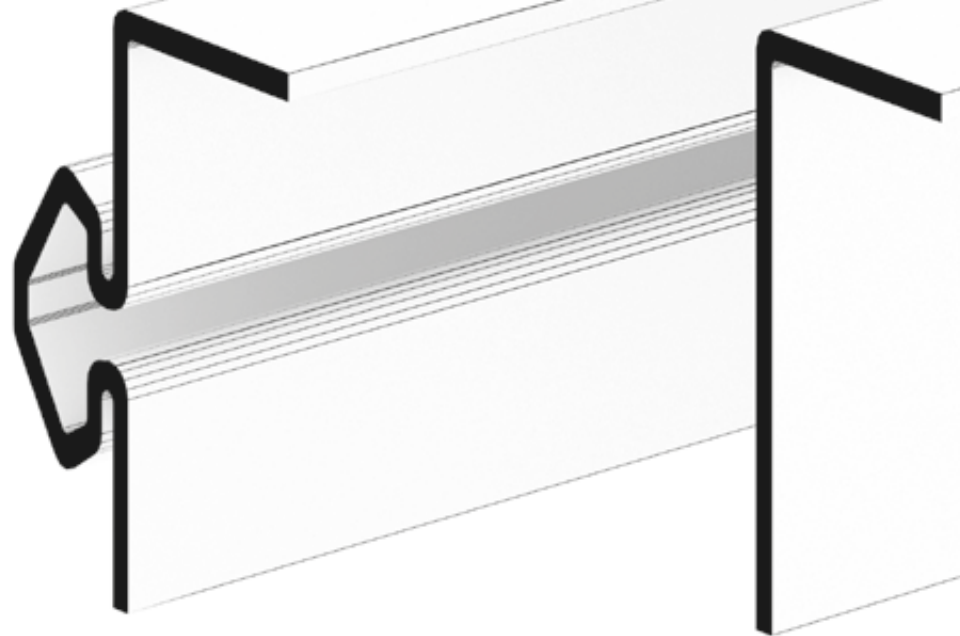

1 CONTROTELAIO

SUBFRAME

REGOLAZIONI DI POSA LIBERE LUNGO ASSI X,Y,Z

Effepi®, per risolvere ogni problematica di installazione e ridurre i tempi di montaggio, propone **due sistemi brevettati di controtelaio:**

GOLA adatto per nuove costruzioni, viene installato esclusivamente con cemento;

GABBIETTE per la sostituzione di porte esistenti, viene installato con cemento o tramite tasselli. Entrambi i controtelai possono essere corredati di 'alette' esterne per finitura a muro.

Effepi®, has patented two innovative subframe systems to solve any installation problems and reduce assembly times:

GROOVED RAILS suitable for new constructions, is installed exclusively with cement;

SMALL BOXES for the replacement of existing doors, it is installed with cement or bolts.

Both the subframes can be fitted with external 'wings' for wall finish.



2 TELAIO

FRAME

4MM DI ACCIAIO DOPPIO SPESSORE

Il telaio portante Effepi® è realizzato in profilato d'acciaio di 2 mm di spessore ripiegato di 360° sulla battuta (nel punto di possibile effrazione diventa quindi di 4 mm). Viene fissato al controtelaio con piastrini sagomati zigrinati, filettati e con viti a brugola quasi a comporre un corpo unico.

Il sistema di regolazioni Effepi® permette inoltre di adattare la posa in opera su tre assi ortogonali e di correggere le eventuali torsioni dei montanti telaio, nel caso in cui il controtelaio venga installato fuori piombo o divergente.

Due i modelli prodotti: P1 (tradizionale) e P5 (per porte Compact).

The Effepi® bearing frame is made of 2 mm thick steel, 360° folded over the rebate (in the section where a break-in is possible the steel profile is 4 mm thick). It is fastened to the subframe by means of modelled knurled and threaded plates and Allen screws which almost make up a single body. The Effepi® adjustment system enables to fit it on three orthogonal axis and to correct jamb torsions, that can occur if the subframe is installed in a diverging way or out of plumb. The two available frame models are: P1 (standard) and P5 (for Compact doors).



FORTI SI NASCE

dove siamo diversi e perchè siamo meglio:

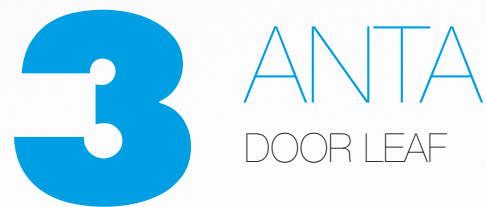

PROFILO STRUTTURALE PIEGATO 20 VOLTE

Il processo di produzione delle ante è particolarmente accurato, per ottenere, da ogni componente tecnica, la massima solidità. Il profilato perimetrale dell'anta (**brevetto Effepi®**) è realizzato con nastro in acciaio di 1.5 mm di spessore ripiegato più volte fino a diventare elemento strutturale che in alcuni punti può raggiungere i 12 mm.

Una doppia lamiera in acciaio e omega di rinforzo verticali completano l'anta che, successivamente al lavoro di carpenteria e finitura, viene sottoposta a scrupolosi passaggi di pulitura e verniciatura a forno a 200°.

The production process of the doors is particularly accurate, to obtain, from each technical component, the maximum solidity.

The perimetral profile of the door leaf (**Effepi® patent**) is made of a 1.5 mm thick steel profile, which has been multi-folded until it becomes a structural element that can reach 12 mm in some points.

A double sheet-steel and omega-shaped profiles, as vertical reinforcements, complete the door leaf which, subsequent to the carpentry work and finishing, undergoes meticulous cleaning procedures and is varnished in a kiln at 200°.

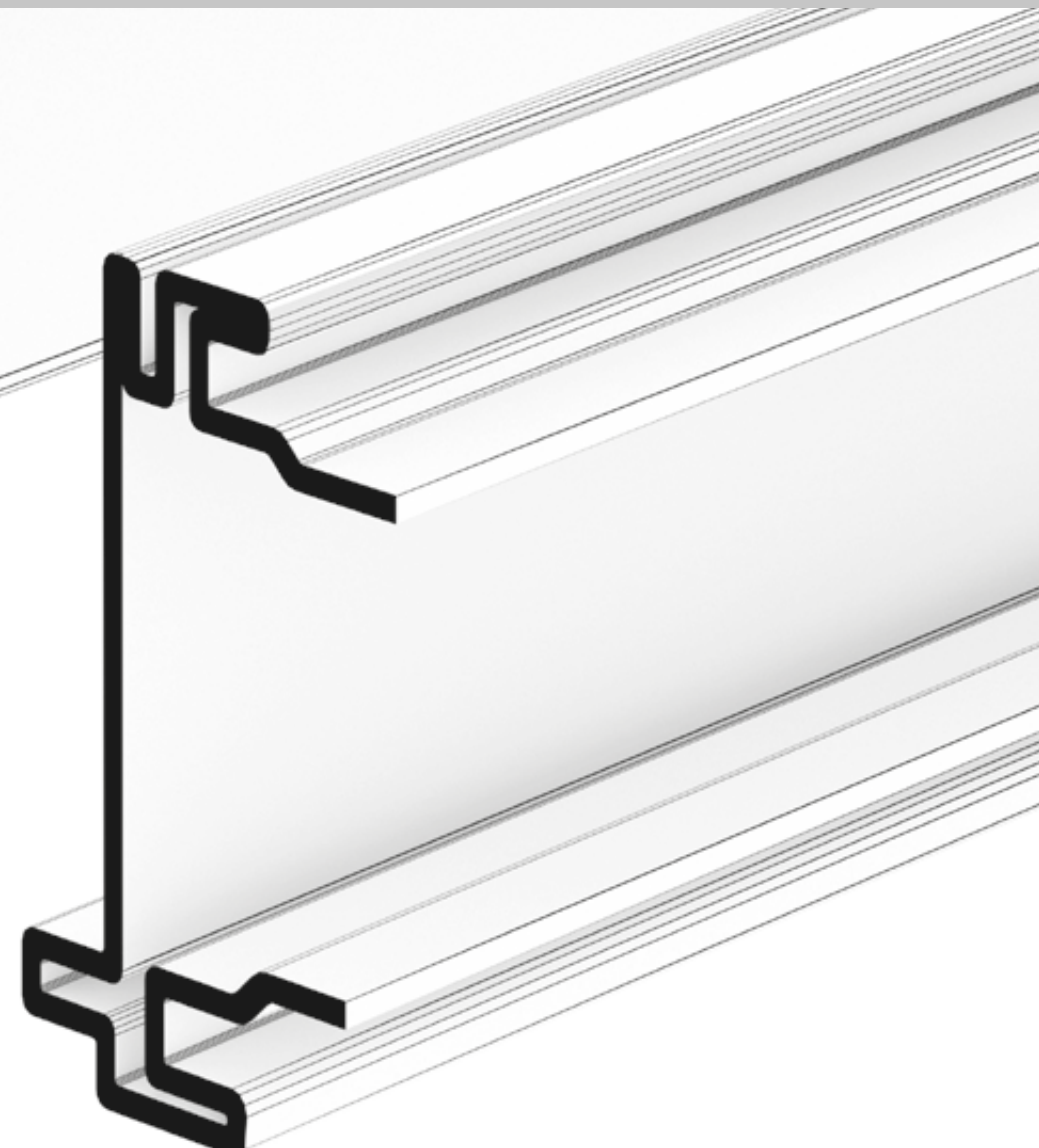



FORTI SI NASCE

dove siamo diversi e perchè siamo meglio:

CERNIERE STANDARD STANDARD HINGES

Realizzate in acciaio di elevato spessore, le cerniere vengono inserite all'interno dei profilati del telaio dell'anta e quindi saldate internamente garantendo così l'invulnerabilità agli arnesi da scasso.

Tenute da spine in acciaio temperato, sono registrabili alto/basso e integralmente verniciate come l'anta e il telaio.

SUPERFICI INIMITABILI

Assoluta pulizia dei profili, assenza di viti a vista o altri sistemi di fissaggio, superfici completamente verniciate. Stesse finiture di colore per anta, telaio e cerniere; verniciate completamente a polveri (high quality coating) nelle finiture marrone Ral 8017, nero Ral 9005, bianco Ral 9010 con l'esclusivo effetto satin, e Ral 9007 alluminio metallizzato di assoluto design.

Functional accessories for moving the leaf. They are made of a very thick steel plate. They are fixed inside the frame and door profile and then internally soldered in order to be burglarproof. They rotate on little spheres and can be vertically adjusted. They are fixed by steel tempered pins. The hinges are coated integrally with the leaf and the frame.

INIMITABLE SURFACES

Absolute cleaning of sections, absence of visible screws or other fasteners, fully painted surfaces. Same colour finishes for door, frame and hinges; completely powder painted in brown Ral 8017, black Ral 9005, white Ral 9010 finishes with the exclusive satin effect and Ral 9007 metallic aluminium of absolute design effect.

4 CERNIERE

ad alta portanza



A SCOMPARSA RECESSED HINGES

Collocate all'interno del telaio e dell'anta in posizione non visibile. Di resistenza e portanza superiore ad ogni modello in commercio, le cerniere a scomparsa Effepi® consentono di ruotare l'anta, liberando completamente il vano di passaggio.

The recessed hinges, placed inside the frame and the door leaf so as not to be seen, are characterised by remarkable resistance and carrying capacity, which is way superior to any model on the market and allow a door opening leaving the passage completely free.

FORTI SI NASCE

dove siamo diversi e perchè siamo meglio:

5

RIVESTIMENTI

pannelli avvolgenti lato cerniere

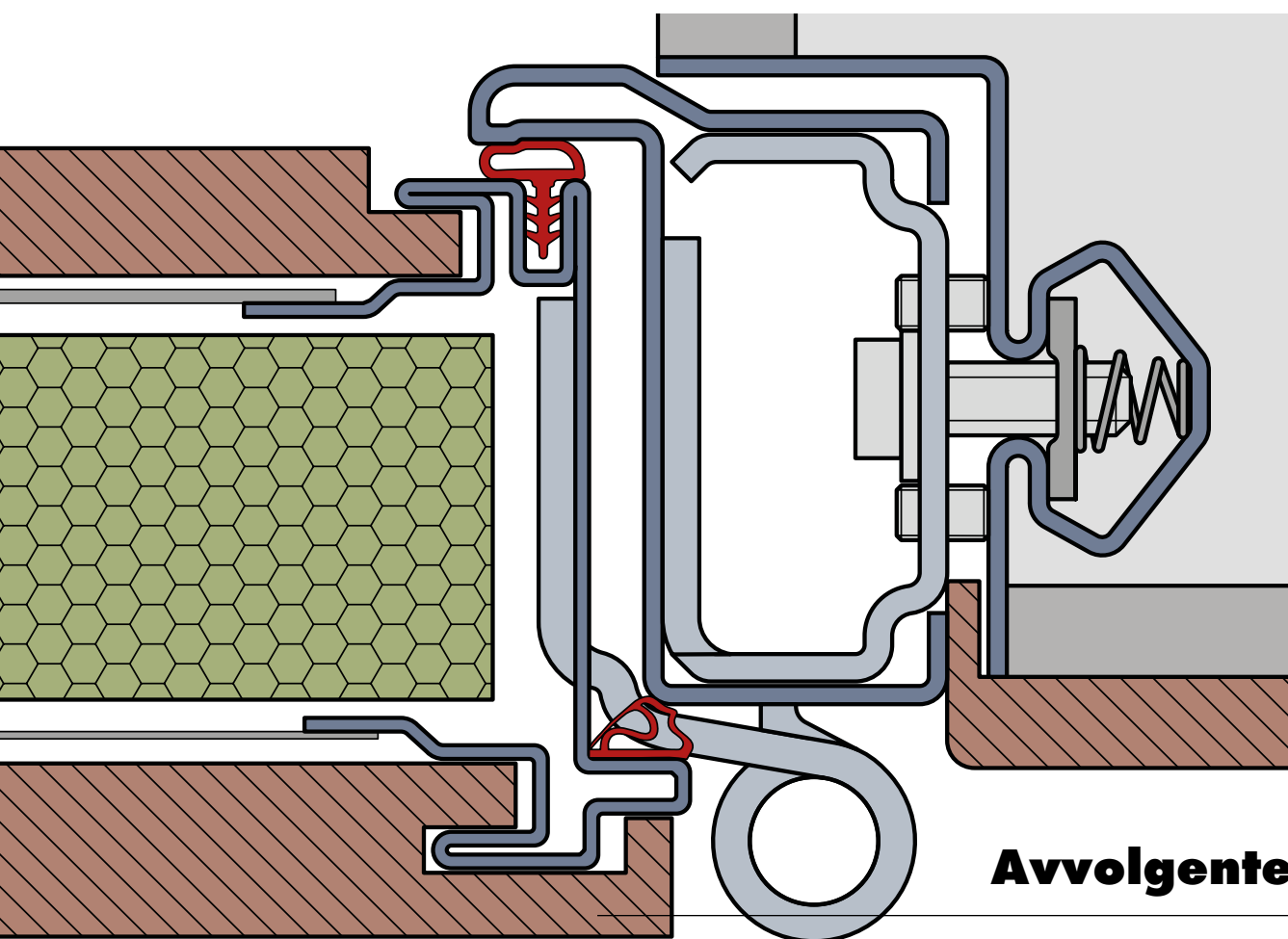

PANNELLI A INFILARE SLIDE-IN PANELS

L'immagine della porta blindata deve avere la stessa cura che da sempre dedichiamo nel renderla sicura ed affidabile.

Partendo da queste considerazioni abbiamo voluto eliminare quei limiti estetici che sovente condizionano la porta di sicurezza.

I rivestimenti, lato interno ed esterno, sono infilabili sull'anta della porta dal basso verso l'alto. Questo originale sistema di installazione di rivestimenti permette un notevole risparmio di tempo e un gradevole aspetto estetico.

Il rivestimento avvolgente EFFEPI® permette l'integrale copertura del bordo metallico dell'anta, non ha fissaggi in vista ne cornici riportate.

The image of the armoured door must receive the same attention which we have always dedicated to making it safe and reliable.

Starting from these considerations, we wanted to eliminate those aesthetical limits which often condition safety doors.

All indoor and outdoor panels can be slid into the leaf of the door from the bottom up. This original panel installation system saves considerable time and endows a pleasant aesthetical appearance.

Exclusive feature of EFFEPI® armoured doors allows the metallic border of the leaf to be covered completely. The wrapped panel has no visible fixings or inserted frames.



EFFEPI CLICK

sistema di applicazione dei pannelli di rivestimento

Sequenza di montaggio



1



2

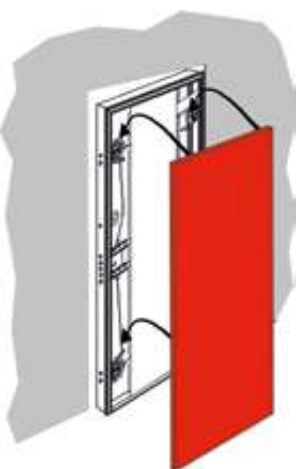

3

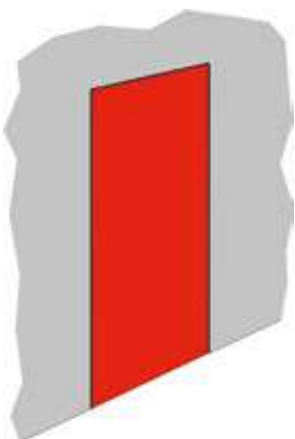

4

Il nuovo sistema EFFEPI-CLICK, mediante appositi ganci sagomati/clips permette di applicare i pannelli di rivestimento (lato cerniere) per porte blindate senza fissaggi in vista, in qualsiasi momento, anche a porta già installata.

VANTAGGI:

- Possibilità di cambiare in qualsiasi momento e in poco tempo il pannello di rivestimento senza dover smontare la porta e senza l'ausilio di personale specializzato.
- Semplifica notevolmente qualsiasi opera di manutenzione in particolare quando si deve sostituire la serratura o qualsiasi parte interna alla porta.
- Maggiore sicurezza nell' evitare danni in fase di trasporto, può essere spedito separatamente dalla porta.
- Maggiore sicurezza nell' evitare danni in cantiere, si può installare sulla porta quando tutte le operazioni di cantiere sono terminate.
- **MANODOPERA DI UN SOLO OPERATORE PER APPLICARE IL RIVESTIMENTO.**
- In caso di porte a due ante, possibilità di rendere perfettamente coplanare l'anta principale con l'anta secondaria semplicemente spessorando il pannello.

The new EFFEPI-CLICK system, with special shaped hooks and clips, allows to apply the panels for armoured doors (hinge side panel) without any visible fixing, at any time, even if the door has been already installed.

BENEFITS:

- Possibility to change at any time and quickly the panel without removing the door and without employing any specialized personnel.
- It simplifies any maintenance work especially when you have to replace the lock or every internal part of the door.
- More safety during the transportation, It can be shipped separately from the door.
- More safety in the building. It can be installed on the door when all jobs are finished.
- **ONE SINGLE OPERATOR TO APPLY THE PANEL.**
- In case of double leaves doors, possibility of making the main leaf perfectly coplanar with the secondary leaf simply shimming the panel.





LE SERRATURE

Meccanica o elettronica, il TOP della tecnologia



MECCANICA **MECHANICAL LOCK**

La serratura meccanica accetta due tipi di chiavi: chiave 'a doppia mappa' o chiave con 'cilindro a profilo europeo'. Entrambe possono essere corodate con sistema differenziato di apertura e chiusura che utilizza 'chiavi padronali' e 'chiavi di servizio'. La lettera 'Q' che contraddistingue i modelli di serratura meccanica scelti da Effepi®, significa **massima sicurezza**, ovvero che sono dotati di 'trappole' anti intrusione per vanificare l'uso di arnesi da scasso.

The mechanical lock uses two types of keys: 'double-bit lock' key or 'Europrofile cylinder' key. Both can be equipped with graduated opening and closing system that uses 'master keys' and 'service keys'. The letter 'Q' that distinguishes the mechanical lock models chosen by Effepi®, means **maximum security**, or that are equipped with **anti-intrusion 'traps'** to prevent the use of burglary tools.



ELETTRONICA **ELECTRONIC LOCK**

Questo tipo di serratura è motorizzato con elettronica di controllo integrata. La versione base si apre dall'interno digitando una pulsantiera (abilitata anche per la programmazione personalizzata) e, dall'esterno, con chiavi elettroniche riconosciute a contatto. Chiudendo l'anta la serratura aziona sempre le mandate mettendo in costante sicurezza la porta. Altre versioni consentono l'apertura dall'esterno con tastierino a codice numerico, oppure con lettore biometrico di impronta digitale. La serratura ha inoltre in dotazione una chiave che aziona un cilindro meccanico di sicurezza, in ausilio a inconvenienti dell'elettronica.

This type of lock is powered by integrated control electronics. The basic version is opened from the inside by typing on a keypad (also enabled for custom programming) and, from the outside, with electronic contact keys. By closing the door the lock is always operated giving the door constant security. Other versions allow the opening from the outside with a numerical code keypad or biometric fingerprint reader. The lock also comes with a key which activates a mechanical cylinder, to help out in case of electronic drawbacks.



SERRATURA MECCANICA MECHANICAL LOCK



**DOPPIA MAPPA
DOUBLE BIT LOCK**

1 Dotata di gorges antidecodificazione, questo tipo di serratura utilizza la chiave con due alette (mappe) a costante variabile. Le chiavi, opportunamente sagomate per ogni singolo nucleo della serratura, vengono fornite sigillate. Il nucleo di apertura e chiusura è sostituibile dall'interno, evitando così di cambiare l'intera serratura.

Equipped with anti decoding gorges, this type of lock uses the key with two tabs (maps) of variable consistency. The keys, suitably shaped to each individual lock core, are provided sealed. The opening and closing core can be replaced from the inside, avoiding the need to change the entire lock.



**SERRATURA A CILINDRO EUROPEO
EUROPROFILE CYLINDER LOCK**

2 La serratura è predisposta per il montaggio di un cilindro di sicurezza a profilo europeo (antistrappo - antitrapanatura). La chiave è di dimensioni contenute, duplicabile esclusivamente con 'carta di proprietà'.

La serratura a cilindro europeo può essere richiesta in differenti modelli:

- **SILENT** serratura con movimento ad ingranaggi – sistema estremamente silenzioso che riduce al minimo lo sforzo di rotazione della chiave
- **AUTOMATIC** la serratura si chiude automaticamente in modo meccanico alla chiusura della porta
- **SBLOCCO E RIARMO RAPIDO** azionamento della serratura esclusivamente con la maniglia interna, senza l'ausilio della chiave.

The lock is designed for the installation of a Europrofile cylinder (pull resistant-drillproof). The key is small, duplicable exclusively with 'property card'. The European cylinder lock can be requested in different models:

- **SILENT** lock with gear movement - extremely quiet system that minimizes the effort of key rotation
- **AUTOMATIC** the lock closes automatically in a mechanical way when the door is closed
- **RAPID UNLOCK AND RESET** operation of the lock exclusively with the inside handle, without the aid of the key.

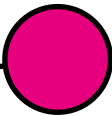

BASIC
SCUDO 5000
SCUDO 5000

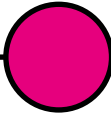

SECURITY
CHAMPIONS PRO
CHAMPIONS PRO

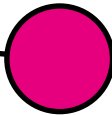

HIGH SECURITY
CHAMPIONS C48
CHAMPIONS C48

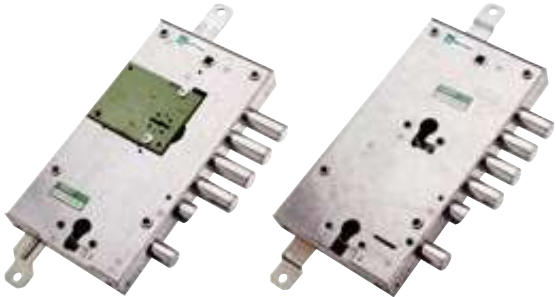
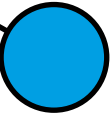
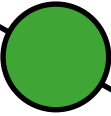

MULTIFUNZIONE
MULTI-FUNCTION LOCK

3

La serratura multifunzione è dotata di doppia chiave di azionamento: 'chiave padronale' e 'chiave di servizio'. La chiave padronale può essere a doppia mappa o a cilindro; la chiave di servizio è solo a cilindro europeo.

The multi-function lock is equipped with two keys: 'master key' and 'service key'. The master key can be double map or cylinder; the service key is only European cylinder.

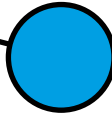

ANTIPANICO
ANTIPANIC

4

La serratura *GORILLA* è un sistema di apertura rapida a spinta per uscite di emergenza. E' una chiusura di sicurezza con più catenacci, appositamente studiata per porte blindate. Spingendo il maniglione si sbloccano tutti i catenacci aprendo la porta. La serratura è dotata di cilindro a profilo europeo e funziona come tutte le serrature tradizionali.

The *GORILLA* lock is a quick push opening system of the armoured door: in case of emergency. *GORILLA* is a safety closing with several bolts and therefore similar to the armoured door concept. Pushing the push-bar, all of the bolts and the latch of the lock release and the door opens. The lock is provided with a Europrofile cylinder as per standard and can be opened and closed with a key like all standard locks.



CILINDRI A PROFILO EUROPEO

EUROPROFILE CYLINDERS



CILINDRO SCUDO 5000 SCUDO 5000

- Chiave piatta reversibile
 - Spine antitrapano in acciaio temperato
 - Ingegno antistrappo in acciaio
 - 7 pistoncini per la cifratura
 - 5 chiavi sigillate
 - 1 chiave da cantiere
- Flat reversible key
 - Drill-resistant pins in tempered steel
 - Steel pull-resistant device
 - 7 pistons for encryption
 - 5 sealed keys
 - 1 construction key

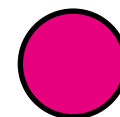

CILINDRO CHAMPIONS PRO CHAMPIONS PRO

Duplicazione chiavi protetta e controllata in categoria 3 da ICIM

- DOPPIO SISTEMA DI CIFRATURA meccanico con 6 perni sagomati + controlli profilo in asse sagomati (brevetto Mottura)
- RESISTENZA AL BUMPING E PICKING certificata ai massimi livelli dall'istituto ICIM
- RESISTENZA AL TRACING la cifratura è protetta dalla tecnica di effrazione che si basa sul "ricalco"
- DISPOSITIVO ANTI-EFFRAZIONE Dispositivo Anti-effrazione In caso di effrazione, il TAGLIO favorisce una rottura controllata del cilindro, evitando che rimanga aperto un foro di passaggio sulla serratura, da cui si potrebbe operare per aprire la porta.
- Spine in widia
- Dispositivo contro la foratura
- 5 Chiavi sigillate
- 1 Chiave da cantiere
- Carta di proprietà protetta per la duplicazione



Protected and controlled key duplication, certified category 3 by ICIM

- DUAL MECHANICAL CODING SYSTEM
- BUMPING AND PICKING RESISTANCE Certified by the ICIM Institute to the highest level requested
- ANTI-BURGLARY DEVICE In the event of attempted burglary, the PRECUT failure system causes controlled breakage of the cylinder, thereby avoiding a through-passing hole being created in the rim lock that could otherwise be used to open the door.
- ANTI-TRACING Widia pins
- Device against perforations
- 5 sealed keys
- 1 construction key
- Protected owner's card for copying



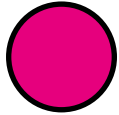

**CILINDRO
CHAMPIONS C48
CHAMPIONS C48**



safeguarding your security

Duplicazione chiavi protetta e controllata in categoria 3 da ICIM

- DOPPIO SISTEMA DI CIFRATURA meccanico (tradizionale con 5 perni) e pista desmodromica con perni rotanti che determinano difficoltà di allineamento sia con mezzi vibranti che con i ferretti di manipolazione per l'apertura illecita
- RESISTENZA AL BUMPING E PICKING certificata Ai massimi livelli dall'istituto ICIM
- DISPOSITIVO ANTI-EFFRAZIONE Dispositivo Anti-effrazione In caso di effrazione, il TAGLIO favorisce una rottura controllata del cilindro, evitando che rimanga aperto un foro di passaggio sulla serratura, da cui si potrebbe operare per aprire la porta.
- Spine in widia
- Dispositivo contro la foratura
- 5 Chiavi sigillate
- Carta di proprietà protetta e controllata per la duplicazione

Protected and controlled key duplication, certified category 3 by ICIM

- DUAL MECHANICAL CODING SYSTEM
- BUMPING AND PICKING RESISTANCE Certified by the ICIM Institute to the highest level requested
- ANTI-BURGLARY DEVICE In the event of attempted burglary, the PRECUT failure system causes controlled breakage of the cylinder, thereby avoiding a through-passing hole being created in the rim lock that could otherwise be used to open the door.
- Widia pins
- Device against perforations
- 5 sealed keys
- Protected and controlled owner's card for copying



SERRATURA ELETTRONICA ELECTRONIC LOCK

Classificata al massimo grado (7)
per la resistenza contro l'effrazione
(EN 12209).

It is classified at the maximum level
(7) for anti-intrusion protection
(UNI EN 12209).

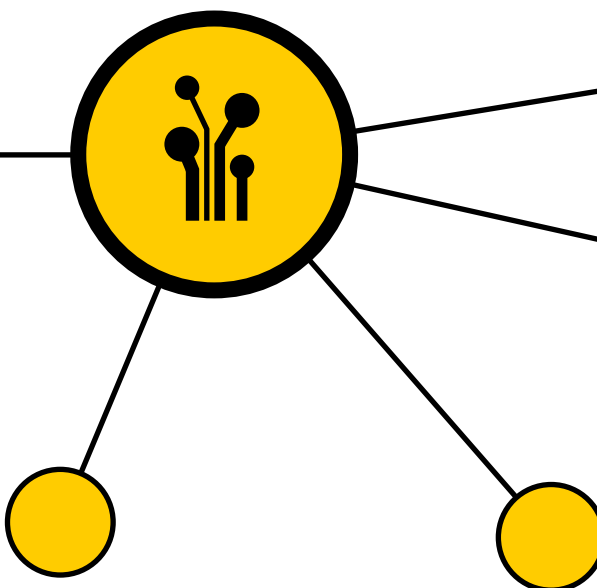

**INTERNO PORTA
INSIDE DOOR**

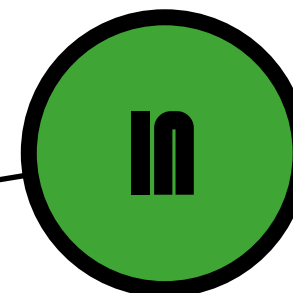

ALIMENTAZIONE A RETE ELETTRICA MAINS POWER SUPPLY

Consigliata per installazioni di nuova costruzione ed edifici
con grande affluenza di persone (plurifamiliari e/o uffici)

Recommended for installation in new constructions and
buildings with large numbers of people (multi-family and/
or offices)

ALIMENTAZIONE A BATTERIA BATTERY POWERED

Consigliata per sostituzioni di porte esistenti
e/o case unifamiliari

Recommended for the replacement of existing
doors and(or) single family homes



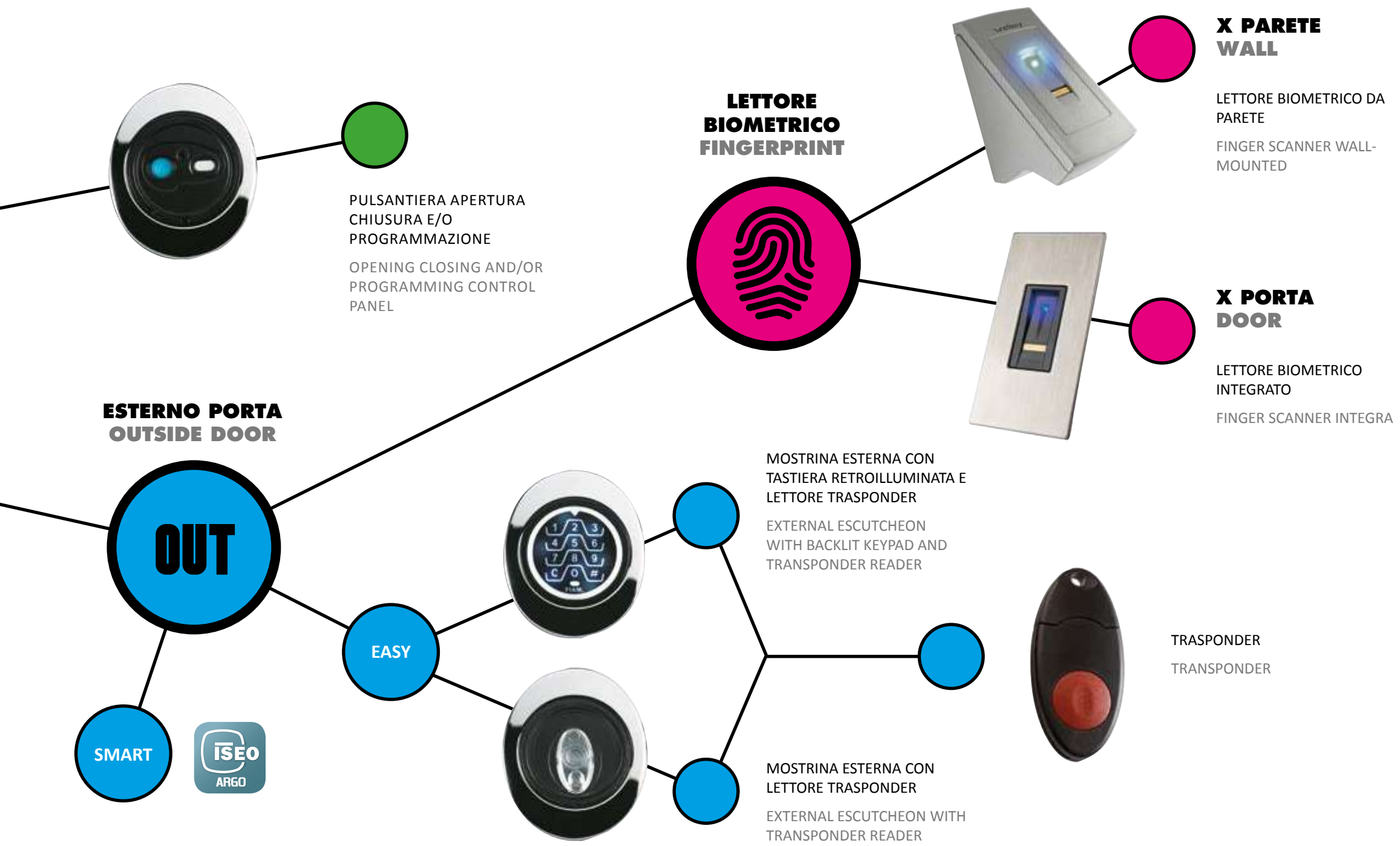

LETTORE BIOMETRICO FINGERPRINT

PULSANTIERA APERTURA CHIUSURA E/O PROGRAMMAZIONE
OPENING CLOSING AND/OR PROGRAMMING CONTROL PANEL

ESTERNO PORTA OUTSIDE DOOR

OUT

EASY

SMART



X PARETE WALL

LETTORE BIOMETRICO DA PARETE
FINGER SCANNER WALL-MOUNTED

X PORTA DOOR

LETTORE BIOMETRICO INTEGRATO
FINGER SCANNER INTEGRA

MOSTRINA ESTERNA CON TASTIERA RETROILLUMINATA E LETTORE TRASPONDER
EXTERNAL ESCUTCHEON WITH BACKLIT KEYPAD AND TRANSPONDER READER

MOSTRINA ESTERNA CON LETTORE TRASPONDER
EXTERNAL ESCUTCHEON WITH TRANSPONDER READER

TRASPONDER
TRANSPONDER





ARGO GESTIONE APERTURA DA TABLET E SMARTPHONE

L'app Argo è disponibile per iOS e Android e permette di aggiungere nuovi dispositivi di apertura come carte, tags or smartphones, leggere lo storico degli eventi, cancellare credenziali perse o rubate, aggiornare x1R Smart con nuove funzionalità software.

Argo App, available for iOS and Android, allows to add new opening devices like cards, tags or phones, retrieve events logs, delete lost/stolen credentials, and update x1R Smart to new software features.

PRINCIPALI FUNZIONI:

- Supporta sia carte Iseo sia carte Mifare generiche
- Memorizza fino a 300 utenti (carte o smartphones)
- Memorizza gli ultimi 1.000 eventi
- Durata batterie fino a 20.000 aperture con messaggio di batterie scariche
- 5 modalità di funzionamento programmabili dall'utente tramite l'app Argo
- Apertura da remoto
- Software aggiornabile sul campo con lo smartphone Bluetooth Smart Ready
- Rilevazione stato carica batterie
- Sensori rilevamento movimento motore, maniglia interna, catenacci e scrocco
- Rilevazione uso chiave meccanica.
- Segnalazioni luminose ed acustiche

MAIN FUNCTIONS:

- Operates with Iseo cards or Legacy Mifare cards
- Memorizes up to 300 users (cards or phones)
- Stores the last 1000 events
- Battery life up to 20.000 openings with battery low warning signal
- 5 functional modes to be set by the end user by the Argo App
- Remote opening
- Software upgrades on site via Bluetooth Smart Ready phone
- Battery charge status
- Detection sensors for motor, internal handle, bolts and latch movements
- Mechanical key detection
- Light and acoustic signals

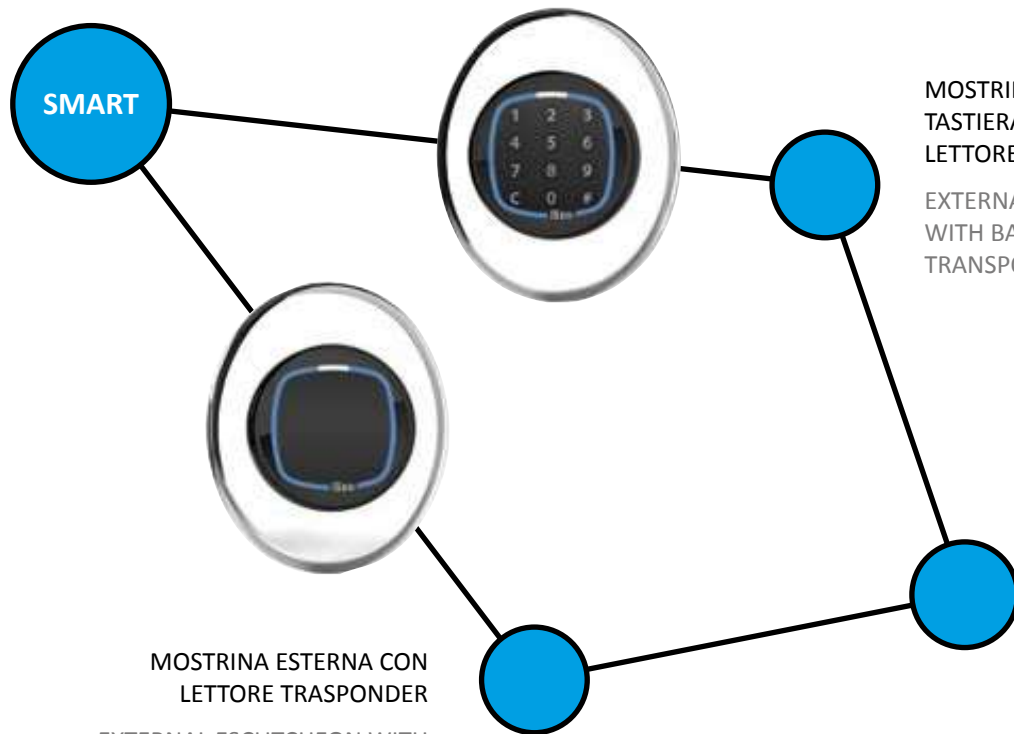

MOSTRINA ESTERNA CON LETTORE TRASPONDER
EXTERNAL ESCUTCHEON WITH TRASPONDER READER

MOSTRINA ESTERNA CON TASTIERA RETROILLUMINATA E LETTORE TRASPONDER

EXTERNAL ESCUTCHEON WITH BACKLIT KEYPAD AND TRASPONDER READER

SERRATURA ELETTRONICA ELECTRONIC LOCK



MASTER CARD

USER CARD



SMART SERRATURA X1R

L'apertura avviene con l'ausilio di un motore o dello sblocco rapido "Single Action" ed in chiusura mediante l'azionamento motorizzato controllato da un microprocessore di ultima generazione. In assenza di alimentazione l'azionamento del catenaccio è garantito dal tradizionale movimento della chiave.

x1R Smart is an electronic motorized lock with a Multistandard ISO 14443 A/B reader. It works with an electric motor controlled by a powerful microprocessor and the deadbolt action is always guaranteed by the mechanical operation of the key, even in case of power supply failure.





Touch me

Design estetica e innovazione

SUPERFICI TATTILI TACTILE SURFACES

Sia in esterni sia in interni, la sicurezza delle porte blindate Effepi® può indossare l'abito che vuoi.

Un'ampia gamma di superfici belle da vedere e gradevoli da toccare, compongono il nostro catalogo di rivestimenti.

Molteplici colori, materiali e composizioni, per una libera scelta di gusto.

Both external and internal, the safety of Effepi® armoured doors can wear the design you desire.

A wide range of elegant surfaces which are a pleasure to touch, make up our catalogue of finishes.

A variety of colours, materials and textures, to a free choice of taste.





E-WAY COLLECTION

UN'ECCELLENZA DEL DESIGN ITALIANO EXCELLENCE OF ITALIAN DESIGN

La porta d'ingresso è il primo contatto con la casa e con la personalità di chi la abita. E' componente estetica e funzionale dell'architettura. Effepi® ha una lunga storia di primati.

Fra questi, quello di aver anticipato il design di prodotto nel settore delle porte blindate. Un caso esemplare è la collezione **E-Way, la prima porta blindata traslante scorrevole raso muro.**

Selezionata dall'Osservatorio Permanente del Design per la pubblicazione **ADI Design Index 2012**, ha partecipato al conferimento del XXIII Premio Compasso d'Oro ADI.

The front door is the first contact with the home and with the personality of those who live there. It is aesthetic and functional component of the architecture. Effepi® has a long history of records. Among these, that of having anticipated the product design in the field of security doors. An example of this is the **E-Way collection, the first Flush wall armoured swivel sliding door.** Selected by the Permanent Design Observatory for the publication in **ADI Design Index 2012**, participated in the awarding of the XXIII Premio Compasso d'Oro ADI.







E-WAY

Porta blindata rasomuro traslante scorrevole manuale
Flush wall armoured swivel sliding door with manual opening



DESCRIZIONE DESCRIPTION

Porta blindata traslante scorrevole filomuro con apertura manuale: i movimenti traslanti di apertura e chiusura avvengono in modo completamente manuale, spingendo o tirando la porta e poi facendola scorrere lateralmente per liberare il vano di passaggio.

Flush wall armoured swivel sliding door with manual opening: the opening/closing swivelling movements are fully manual, operated by pushing or pulling the door and then laterally sliding it to free the passage way.

COLORI TELAIO FRAME COLOR



MARRONE
BROWN
RAL 8017



NERO
BLACK
RAL 9005



ALLUMINIO
ALUMINIUM
RAL 9007



BIANCO
WHITE
RAL 9010

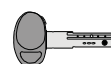
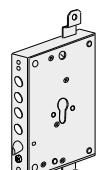

9 PUNTI DI CHIUSURA LOCK POINT

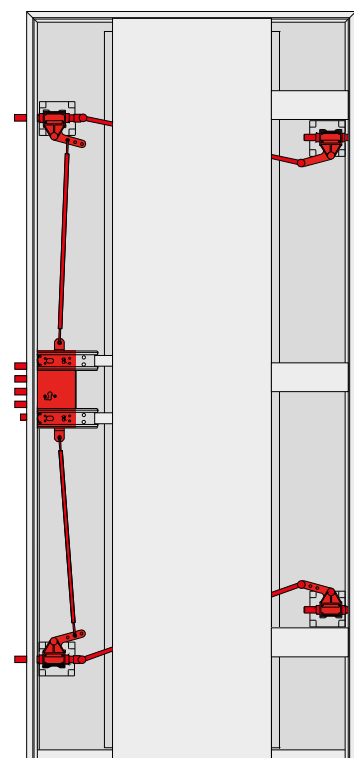

DATI TECNICI DI SERIE STANDARD TECHNICAL DATA

- Controtelaio in lamiera zincata con cassonetto superiore
- Telaio profilato Tipo P1 regolabile, spessore 20/10 in acciaio verniciato con polveri poliestere
- Struttura perimetrale dell'anta in acciaio profilato 15/10, anta doppia lamiera 15/10 e 8/10 con rinforzi verticali interni a "Z", verniciata con polveri poliestere
- Anta sospesa su agganci superiori regolabili e biella inferiore anti-oscillamento
- Serratura a cilindro profilo europeo con protezione in lamiera al manganese e defender antitrapano
- Punti di chiusura : n. 9 in acciaio \varnothing 18 mm
- Doppia guarnizione di battuta sull'anta
- Coibentazione interna dell'anta con EPS
- Tagliaspifferi con guarnizione multilabbro autolivellante
- Spioncino grandangolare
- Subframe made of galvanised sheet metal with upper box
- Frame P1 adjustable, 20/10 thick steel painted with polyester powders
- Perimeter structure of leaf in 15/10 steel profile, 15/10 and 8/10 double sheet metal, internal vertical reinforcements to "Z", painted with polyester powders
- Hanging door leaf on adjustable upper hooks and lower anti-sway coupling rod
- Europrofile cylinder Lock with Defender and with manganese sheet metal protection
- Locking points : n. 9, made of steel \varnothing 18 mm
- Double gasket on the door
- Insulation inside door with EPS
- Draught proofing with self-levelling multi-lip gasket
- Peephole wide angle lens





MILANO
Offici

E-WAY



E-WAY

MANIGLIERIA HANDLES

La maniglia interna ha la duplice funzione di richiamare lo scrocco e di tirare a sé la porta per poi farla scorrere parallelamente alla parete e liberare l'uscio. Sul lato esterno, la maniglia ad incasso dall'originale design Effepi® consente di far traslare e scorrere la porta in apertura e chiusura. Il modello della pagina accanto è abbinato al rivestimento raso muro in finitura encausto.

The inside handle has the dual function of recalling the latch and pull the door towards it to allow it to slide laterally and free the doorway. On the outside, the recessed handle with the original Effepi® design allows to translate and slide the door in opening and closing. The model shown on the next page is combined with flush wall covering panel and encaustic finishing.





E-WAY DRIVE





Porta blindata rasomuro traslante scorrevole automatica assistita
Flush wall armoured swivel sliding door with automatic power-assisted opening

DESCRIZIONE DESCRIPTION

Porta blindata traslante scorrevole filomuro con apertura **AUTOMATICA ASSISTITA**: una volta azionata manualmente la serratura, il movimento traslante avviene manualmente e lo scorrimento laterale avviene automaticamente premendo un apposito tasto posto sul telaio della porta.

Flush wall armoured swivel sliding door with automatic power-assisted opening: once the lock has been manually operated, the swivelling movement occurs manually, and the lateral sliding automatically occurs by pushing a button.

COLORI TELAIO FRAME COLOR

			
MARRONE BROWN RAL 8017	NERO BLACK RAL 9005	ALLUMINIO ALUMINIUM RAL 9007	BIANCO WHITE RAL 9010

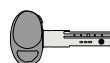
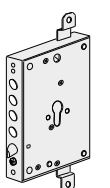

9 PUNTI DI CHIUSURA LOCK POINT

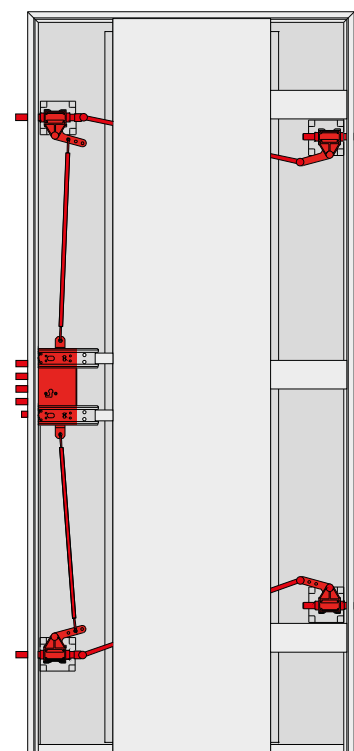

DATI TECNICI DI SERIE STANDARD TECHNICAL DATA

- Controtelaio in lamiera zincata con cassonetto superiore
- Telaio profilato Tipo P1 regolabile, spessore 20/10 in acciaio verniciato con polveri poliestere
- Struttura perimetrale dell'anta in acciaio profilato 15/10, anta doppia lamiera 15/10 e 8/10 con rinforzi verticali interni a "Z", verniciata con polveri poliestere
- Anta sospesa su agganci superiori registrabili e biella inferiore anti-oscillamento
- Serratura a cilindro profilo europeo con protezione in lamiera al manganese e defender antitrapano
- Punti di chiusura : n. 9 in acciaio \varnothing 18 mm
- Doppia guarnizione di battuta sull'anta
- Coibentazione interna dell'anta con EPS
- Tagliaspifferi con guarnizione multilabbro autolivellante
- Spioncino grandangolare
- Subframe made of galvanised sheet metal with upper box
- Frame P1 adjustable, 20/10 thick steel painted with polyester powders
- Perimeter structure of leaf in 15/10 steel profile, 15/10 and 8/10 double sheet metal, internal vertical reinforcements to "Z", painted with polyester powders
- Hanging door leaf on adjustable upper hooks and lower anti-sway coupling rod
- Europrofile cylinder Lock with Defender and with manganese sheet metal protection
- Locking points : n. 9, made of steel \varnothing 18 mm
- Double gasket on the door
- Insulation inside door with EPS
- Draught proofing with self-levelling multi-lip gasket
- Peephole wide angle lens





1 A porta chiusa, la veletta mobile e la superficie interna della porta sono entrambe a raso muro.

When the door is closed, the mobile cover and the inner surface of the door are both flush to the wall.



2 Nel movimento di traslazione, la veletta e la porta escono simultaneamente dalla parete.

During the translation movement, the mobile cover and the door simultaneously leave the wall.



3 Nel movimento di scorrimento e apertura della porta parallelamente alla parete, la veletta resta ferma.

During the sliding and opening movement of the door parallel to the wall, the mobile cover does not move.



VELETTA MOBILE MOBILE COVER

La veletta mobile sulla parte superiore integra perfettamente l'elemento porta con lo spazio interno; nascondendo i meccanismi nell'intera fase di traslazione di apertura e chiusura.

The mobile cover on the top perfectly complements the door element to the internal space; hiding the translation mechanisms throughout the opening and closing phase.





E-WAY MATIC

Porta blindata rasomuro traslante scorrevole automatica
Flush wall armoured swivel sliding door with automatic opening



DESCRIZIONE DESCRIPTION

Porta blindata traslante scorrevole filomuro con apertura AUTOMATICA: sia l'apertura/chiusura della serratura che il movimento traslante e lo scorrimento avvengono in modo completamente automatico, azionati tramite telecomando, pulsante remoto, lettore d'impronta digitale biometrica, tastiera numerica o sensore di prossimità.

Flush wall armoured swivel sliding door with automatic opening: both lock opening/closing movements and the swivelling and sliding movements are fully automatic, operated through remote control, remote button, biometric digital finger print reader, numeric keypad or proximity sensor.

COLORI TELAIO FRAMES COLOR



MARRONE
BROWN
RAL 8017



NERO
BLACK
RAL 9005



ALLUMINIO
ALUMINIUM
RAL 9007



BIANCO
WHITE
RAL 9010

9 PUNTI DI CHIUSURA LOCK POINT

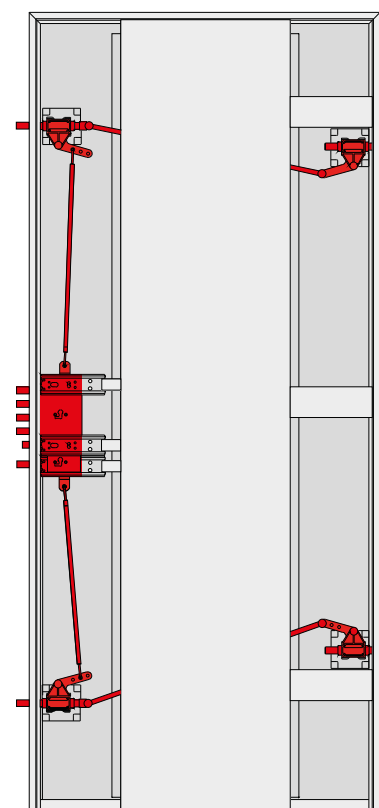
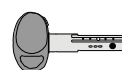
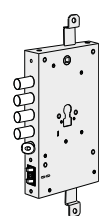

DATI TECNICI DI SERIE STANDARD TECHNICAL DATA

- Controtelaio in lamiera zincata con cassonetto superiore
- Telaio profilato Tipo P1 regolabile, spessore 20/10 in acciaio verniciato con polveri poliestere
- Struttura perimetrale dell'anta in acciaio profilato 15/10, anta doppia lamiera 15/10 e 8/10 con rinforzi verticali interni a "Z", verniciata con polveri poliestere
- Anta sospesa su agganci superiori registrabili e biella inferiore anti-oscillamento
- Serratura elettronica con apertura tramite chiave trasponder, tastiera numerica o lettore biometrico di impronta digitale e manualmente con cilindro a profilo europeo protetto con defender antitrapano
- Punti di chiusura : n. 9 in acciaio \varnothing 18 mm
- Doppia guarnizione di battuta sull'anta
- Coibentazione interna dell'anta con EPS
- Tagliaspifferi con guarnizione multilabbro autolivellante
- Spioncino grandangolare
- Subframe made of galvanised sheet metal with upper box
- Frame P1 adjustable, 20/10 thick steel painted with polyester powders
- Perimeter structure of leaf in 15/10 steel profile, 15/10 and 8/10 double sheet metal, internal vertical reinforcements to "Z", painted with polyester powders
- Hanging door leaf on adjustable upper hooks and lower anti-sway coupling rod
- Electronic lock opening by a transponder key, numerical keypad or biometric fingerprint reader and manually with Europrofile cylinder with Defender
- Locking points : n. 9, made of steel \varnothing 18 mm
- Double gasket on the door
- Insulation inside door with EPS
- Draught proofing with self-levelling multi-lip gasket
- Peephole wide angle lens







E-WAY MATIC

PUNTI DI CHIUSURA MOBILI MOBILE LOCKING POINTS

Il doppio congegno di catenacci mobili posti sui due fianchi, fanno di E-Way una porta blindata estremamente sicura. Grazie al sistema nascosto di sostegno inferiore, il **movimento di scorrimento è piacevolmente fluido** e non presenta binari a terra sul vano di passaggio.

Doppie battute e doppie guarnizioni garantiscono una perfetta tenuta all'aria.

The double mechanism of moving bolts placed on both sides, make E-Way an extremely safe armoured door. The hidden lower support system, **allows for a pleasantly smooth sliding movement** and the passage way is free from tracks on the ground. A double rebate and double gasket system guarantees perfect air tightness.







IMMENSA

IL PRIMATO DELLA QUALITÀ THE SUPREMACY OF QUALITY

Porte blindate con cerniere a scomparsa, la collezione Immensa si presenta con la personalità di veri e propri complementi d'arredo. Dalle linee essenziali, priva di meccanismi a vista, con la versione ***Immensa rasomuro***, Effepi® mette a disposizione di architetti e designer un innovativo concetto di sicurezza che si integra perfettamente con l'architettura, creando **superfici planari e omogenee fra porta e parete.**

La forza della solidità in un corpo dalle linee leggere, fanno di Immensa **una porta blindata di assoluto prestigio**, pronta ad accogliere un'ampia gamma di rivestimenti e materiali di tendenza.

Armoured doors with recessed hinges, the Immensa collection comes with the personality of real furnishing accessories.

Essential lines, with no visible mechanisms, with the ***Immensa flush wall*** version, Effepi® provides architects and designers an innovative safety concept that is perfectly integrated into the architecture, creating **planar and uniform surfaces between the door and wall.** The strength of the solidity in a body of lightweight appearance, make Immensa a **prestigious security door**, ready to host a wide range of panels and trendy materials.



4

CLASSE

IMMENSA rasomuro

Porta blindata rasomuro complanare con cerniere a scomparsa, apertura a 110°
Flush wall security door with recessed hinges, opening to 110°

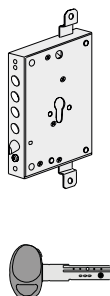

11 PUNTI DI CHIUSURA LOCK POINT

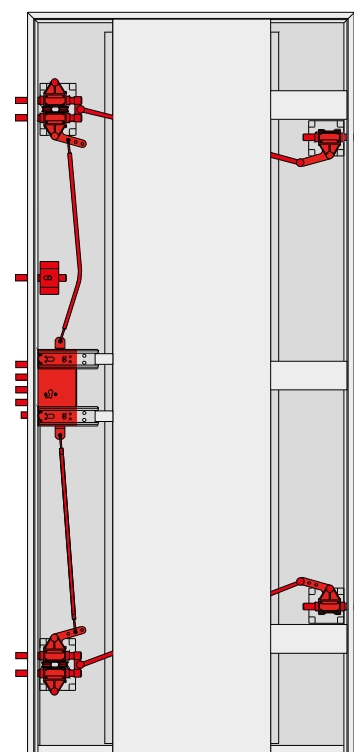

DATI TECNICI DI SERIE STANDARD TECHNICAL DATA

- Pretelaio complanare a gabbiette in lamiera zincata con profilo rasomuro
- Telaio profilato Tipo P1 regolabile, spessore 20/10 in acciaio verniciato con polveri poliesteri
- Struttura perimetrale dell'anta in acciaio profilato 15/10, anta doppia lamiera 15/10 e 8/10 con rinforzi verticali interni a "Z", verniciata con polveri poliesteri
- Serratura a cilindro profilo europeo con protezione in lamiera al manganese e defender antitrapano
- Punti di chiusura : n. 11 in acciaio ø18 mm
- Doppia guarnizione di battuta sull'anta
- Coibentazione interna dell'anta con EPS
- Tagliaspifferi con guarnizione multilabbro autolivellante
- Spioncino grandangolare
- Limitatore d'apertura
- Cerniere a scomparsa registrabili in altezza e profondità, apertura a 110°
- Subframe Complanar version made of galvanised sheet metal with aluminium profile
- Frame P1 adjustable, 20/10 thick steel painted with polyester powders
- Perimeter structure of leaf in 15/10 steel profile, 15/10 and 8/10 double sheet metal, internal vertical reinforcements to "Z", painted with polyester powders
- Europrofile cylinder Lock with Defender and with manganese sheet metal protection
- Locking points : n. 11, made of steel ø18 mm
- Double gasket on the door
- Insulation inside door with EPS
- Draught proofing with self-levelling multi-lip gasket
- Peephole wide angle lens
- Opening limiter
- Recessed hinges adjustable in height and dept, opening to 110°

COLORI TELAIO FRAME COLORS



MARRONE
BROWN
RAL 8017



NERO
BLACK
RAL 9005



ALLUMINIO
ALUMINIUM
RAL 9007



BIANCO
WHITE
RAL 9010







IMMENSA rasomuro

PARTICOLARI CHE FANNO LA DIFFERENZA DETAILS THAT MAKE THE DIFFERENCE

La porta immensa rasomuro è totalmente complanare alla parete. Le cerniere a scomparsa collocate all'interno del telaio e dell'anta in posizione non visibile, sono caratterizzate da notevole resistenza e portanza, ben superiore ad ogni modello in commercio, e permettono una rotazione dell'anta sino a 110°.

I catenacci di forma cilindrica sono azionati dalla serratura e fuoriescono per circa 25mm, sono retrattili ed in caso di chiusura fortuita rientrano nell'anta.

The Immensa Rasomuro door is completely flush to the wall. The recessed hinges, placed inside the frame and the door leaf so as not to be seen, are characterised by remarkable resistance and carrying capacity, which is way superior to any model on the market and allow a door opening of up to 110°.

The cylindrical shape bolts are operated by the lock and protrude by about 25mm. They are retractable and in case of accidental closing they retract into the door.

Particolare angolo
telaio totalmente
integrato nel muro

Detail of the corner of
the frame, completely
integrated in the wall





IMMENSAS

Porta blindata planare con cerniere a scomparsa, apertura a 95°
Security door with recessed hinges, opening to 95°





4
CLASSE

DESCRIZIONE DESCRIPTION

Immensa ha la piacevolezza di un design di assoluto rigore, una superficie planare senza meccanismi, in vista. Immensa ha il pannello di rivestimento in leggera sporgenza dal muro e le cornici leggermente arretrate.

Immensa has a pleasantly simple design in a planar surface with no visible mechanisms. Immensa has a door panel that protrudes slightly from the wall and the frames slightly away from the wall.

COLORI TELAIO FRAME COLORS

			
MARRONE BROWN RAL 8017	NERO BLACK RAL 9005	ALLUMINIO ALUMINIUM RAL 9007	BIANCO WHITE RAL 9010

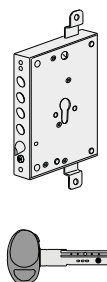

11 PUNTI DI CHIUSURA LOCK POINT

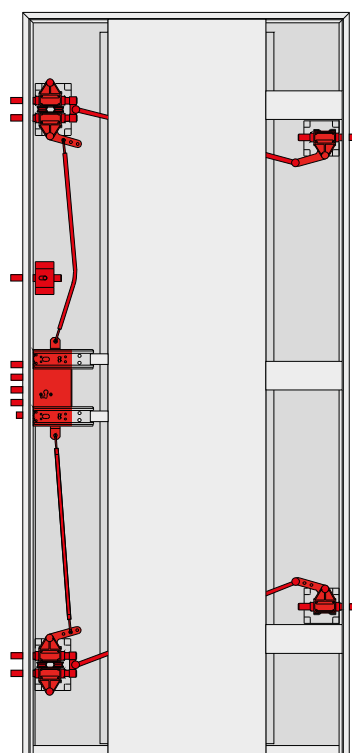

DATI TECNICI DI SERIE STANDARD TECHNICAL DATA

- Controtelaio planare a gabbiette in lamiera zincata
- Telaio profilato Tipo P1 regolabile, spessore 20/10 in acciaio verniciato con polveri poliestere
- Struttura perimetrale dell'anta in acciaio profilato 15/10, anta doppia lamiera 15/10 e 8/10 con rinforzi verticali interni a "Z", verniciata con polveri poliestere
- Serratura a cilindro profilo europeo con protezione in lamiera al manganese e defender antitrapano
- Punti di chiusura : n. 11 in acciaio ø18 mm
- Doppia guarnizione di battuta sull'anta
- Coibentazione interna dell'anta con EPS
- Tagliaspifferi con guarnizione multilabbro autolivellante
- Spioncino grandangolare
- Limitatore d'apertura
- Cerniere a scomparsa Registrabili in altezza e profondità, apertura a 95°
- Subframe planar version made of galvanised sheet metal
- Frame P1 adjustable, 20/10 thick steel painted with polyester powders
- Perimeter structure of leaf in 15/10 steel profile, 15/10 and 8/10 double sheet metal, internal vertical reinforcements to "Z", painted with polyester powders
- Europrofile cylinder Lock with Defender and with manganese sheet metal protection
- Locking points : n. 11, made of steel ø18 mm
- Double gasket on the door
- Insulation inside door with EPS
- Draught proofing with self-levelling multi-lip gasket
- Peephole wide angle lens
- Opening limiter
- Recessed hinges adjustable in height and dept, opening to 95°





MOSTRINA ANTA DOOR ESCUTCHEONS

Assoluta particolarità di Immensa nella versione tradizionale, è il gioco di linee in aggetto che si forma fra parete, mostrine e superficie della porta.

Una soluzione tecnica ed estetica che consente di nascondere le cerniere (invisibili nel movimento di apertura e chiusura), lasciando integra l'eleganza della porta.

Collocate all'interno del telaio e dell'anta, queste speciali cerniere, brevettate da Effepi®, sono caratterizzate da resistenza e portanza ben superiori ad ogni modello in commercio.

La rotazione della porta raggiunge i 95°, I catenacci, di forma cilindrica, fuoriescono di circa 25mm e vengono azionati dalla serratura.

Sono inoltre dotati di un meccanismo di sicurezza che, in caso di chiusura fortuita, li fa rientrare nell'anta, evitando danni al telaio.

A unique peculiarity of Immensa in the traditional version, is the play of projecting lines that is formed between the wall, escutcheons and door surface.

A technical and aesthetic solution that allows you to hide the hinges (invisible in the opening and closing movement), leaving intact the elegance of the door.

Placed inside the frame and the door leaf, these special hinges, patented by Effepi®, are characterised by resistance and carrying capacity well above any model on the market. The door opening reaches 95°. The cylindrical shape bolts protrude by about 25mm and are operated by the lock.

They are also equipped with a safety mechanism which, in case of accidental closure, makes them retract into the door, avoiding damage to the frame.

Particolare cerniera a scomparsa e rostro mobile

Detail of the hidden hinge and mobile bolt



4

CLASSE

DOMOTICA EASY - DOMOTICA SMART

Porte blindate con serratura elettronica motorizzata
Security door with electronic lock



SMART

COLORI TELAIO FRAME COLORS



MARRONE BROWN RAL 8017	NERO BLACK RAL 9005	ALLUMINIO ALUMINIUM RAL 9007	BIANCO WHITE RAL 9010
------------------------------	---------------------------	------------------------------------	-----------------------------

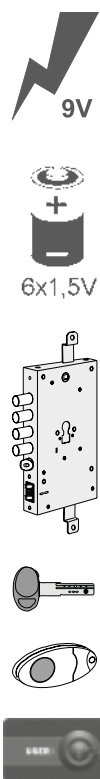

12 PUNTI DI CHIUSURA LOCK POINT

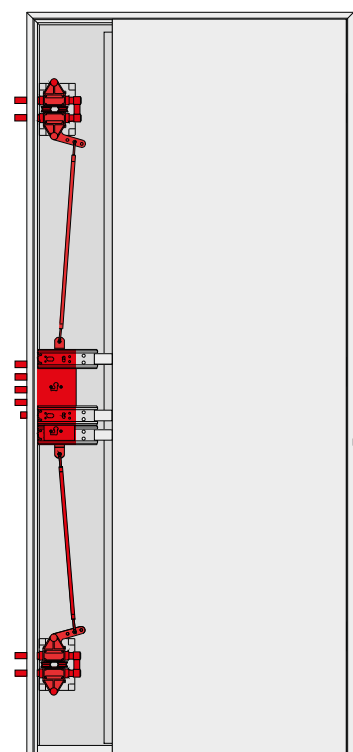

DATI TECNICI DI SERIE STANDARD TECHNICAL DATA

- Controtelaio in lamiera zincata
- Telaio profilato Tipo P1 regolabile, spessore 20/10 in acciaio verniciato con polveri poliestere
- Struttura perimetrale dell'anta in acciaio profilato 15/10, anta doppia lamiera 15/10 e 8/10 con rinforzi verticali interni a "Z", verniciata con polveri poliestere
- Serratura elettronica con apertura tramite chiave trasponder, tastiera numerica o lettore biometrico di impronta digitale e manualmente con cilindro a profilo europeo protetto con defender antitrapano
- Punti di chiusura : n. 12 in acciaio ø18 mm
- Doppia guarnizione di battuta sull'anta
- Coibentazione interna dell'anta con EPS
- Tagliaspifferi con guarnizione multilabbro autolivellante
- Spioncino grandangolare
- Cerniere Registrabili in altezza
- Subframe made of galvanised sheet metal
- Frame P1 adjustable, 20/10 thick steel painted with polyester powders
- Perimeter structure of leaf in 15/10 steel profile, 15/10 and 8/10 double sheet metal, internal vertical reinforcements to "Z", painted with polyester powders
- Electronic lock opening by a transponder key, numerical keypad or biometric fingerprint reader and manually with Europrofile cylinder with Defender
- Locking points : n. 12, made of steel ø18 mm
- Double gasket on the door
- Insulation inside door with EPS
- Draught proofing with self-levelling multi-lip gasket
- Peephole wide angle lens
- Adjustable hinges in height







GARANTE multi CL

4

CLASSE

Il modello GARANTE MULTI CL è abbinato al rivestimento della collezione TRATTO.
The model GARANTE MULTI CL is combined to the TRATTO collection panel.



COLORI TELAIO FRAME COLORS



14 PUNTI DI CHIUSURA LOCK POINT

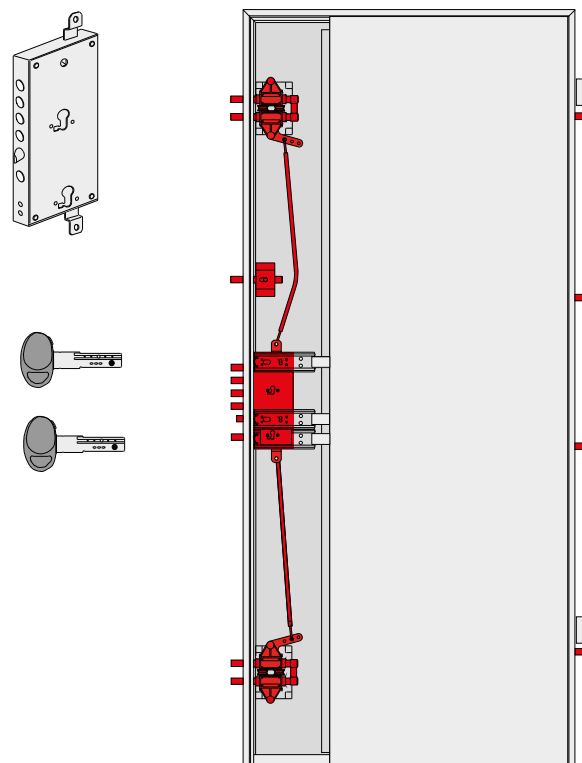

DATI TECNICI DI SERIE STANDARD TECHNICAL DATA

- Controtelaio in lamiera zincata
- Telaio profilato Tipo P1 regolabile, spessore 20/10 in acciaio verniciato con polveri poliestere
- Struttura perimetrale dell'anta in acciaio profilato 15/10, anta doppia lamiera 15/10 e 8/10 con rinforzi verticali interni a "Z", verniciata con polveri poliestere
- Serratura MULTIFUNZIONE, parte superiore: cilindro a profilo europeo protetto da defender antitrapano; parte inferiore: cilindro a profilo europeo con protezione totale della serratura in lamiera al manganese
- Punti di chiusura : n. 14 in acciaio ø18 mm
- Doppia guarnizione di battuta sull'anta
- Coibentazione interna dell'anta con EPS
- Tagliaspifferi con guarnizione multilabbro autolivellante
- Spioncino grandangolare
- Limitatore d'apertura
- Cerniere Registrabili in altezza
- Subframe made of galvanised sheet metal
- Frame P1 adjustable, 20/10 thick steel painted with polyester powders
- Perimeter structure of leaf in 15/10 steel profile, 15/10 and 8/10 double sheet metal, internal vertical reinforcements to "Z", painted with polyester powders
- Upper Lock : Europrofile cylinder with Defender
- Lower Lock : Europrofile cylinder with total protection of the manganese sheet metal lock
- Locking points : n. 14, made of steel ø18 mm
- Insulation inside door with EPS
- Double gasket on the door
- Draught proofing with self-levelling multi-lip gasket
- Peephole wide angle lens
- Opening limiter
- Adjustable hinges in height



4

CLASSE

DIFESA CL

Il modello DIFESA CL è abbinato al rivestimento della collezione PREZIOSI.
The model DIFESA CL is combined to the PREZIOSI collection panel.



13 PUNTI DI CHIUSURA LOCK POINT

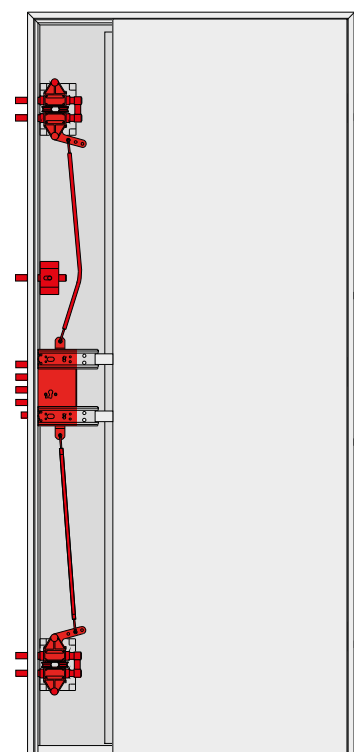
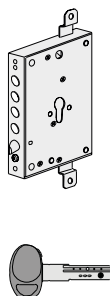

DATI TECNICI DI SERIE STANDARD TECHNICAL DATA

- Controtelaio in lamiera zincata
- Telaio profilato Tipo P1 regolabile, spessore 20/10 in acciaio verniciato con polveri poliestere
- Struttura perimetrale dell'anta in acciaio profilato 15/10, anta doppia lamiera 15/10 e 8/10 con rinforzi verticali interni a "Z", verniciata con polveri poliestere
- Serratura a cilindro profilo europeo con protezione in lamiera al manganese e defender antitrapano
- Punti di chiusura : n. 13 in acciaio ø18 mm
- Doppia guarnizione di battuta sull'anta
- Coibentazione interna dell'anta con EPS
- Tagliaspifferi con guarnizione multilabbro autolivellante
- Spioncino grandangolare
- Limitatore d'apertura
- Cerniere Registrabili in altezza
- Subframe made of galvanised sheet metal
- Frame P1 adjustable, 20/10 thick steel painted with polyester powders
- Perimeter structure of leaf in 15/10 steel profile, 15/10 and 8/10 double sheet metal, internal vertical reinforcements to "Z", painted with polyester powders
- Europrofile cylinder Lock with Defender and with manganese sheet metal protection
- Locking points : n. 13, made of steel ø18 mm
- Double gasket on the door
- Insulation inside door with EPS
- Draught proofing with self-levelling multi-lip gasket
- Peephole wide angle lens
- Opening limiter
- Adjustable hinges in height

COLORI TELAIO FRAME COLORS



MARRONE
BROWN
RAL 8017



NERO
BLACK
RAL 9005



ALLUMINIO
ALUMINIUM
RAL 9007



BIANCO
WHITE
RAL 9010





ARCO CL

Il modello ARCO CL è abbinato al rivestimento della collezione MASSELLO modello FORTUNA.
The model ARCO CL is combined to the MASSELLO collection panel, model FORTUNA.

4

CLASSE



13 PUNTI DI CHIUSURA LOCK POINT

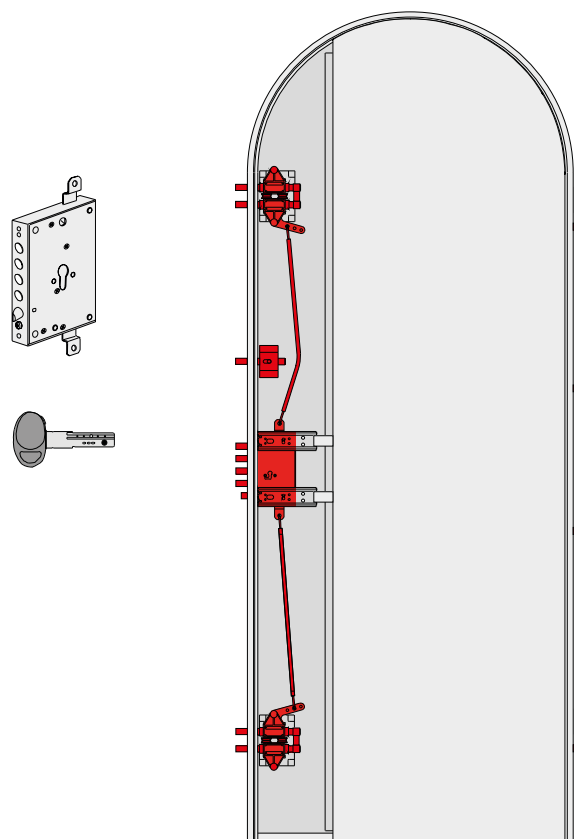

DATI TECNICI DI SERIE STANDARD TECHNICAL DATA

- Controtelaio in lamiera zincata
- Telaio profilato Tipo P1 regolabile, spessore 20/10 in acciaio verniciato con polveri poliestere
- Struttura perimetrale dell'anta in acciaio profilato 15/10, anta doppia lamiera 15/10 e 8/10 con rinforzi verticali interni a "Z", verniciata con polveri poliestere
- Serratura a cilindro profilo europeo con protezione in lamiera al manganese e defender antitrapano
- Punti di chiusura : n. 13 in acciaio ø18 mm
- Doppia guarnizione di battuta sull'anta
- Coibentazione interna dell'anta con EPS
- Tagliaspifferi con guarnizione multilabbro autolivellante
- Spioncino grandangolare
- Limitatore d'apertura
- Cerniere Registrabili in altezza
- Subframe made of galvanised sheet metal
- Frame P1 adjustable, 20/10 thick steel painted with polyester powders
- Perimeter structure of leaf in 15/10 steel profile, 15/10 and 8/10 double sheet metal, internal vertical reinforcements to "Z", painted with polyester powders
- Europrofile cylinder Lock with Defender and with manganese sheet metal protection
- Locking points : n. 13, made of steel ø18 mm
- Double gasket on the door
- Insulation inside door with EPS
- Draught proofing with self-levelling multi-lip gasket
- Peephole wide angle lens
- Opening limiter
- Adjustable hinges in height

COLORI TELAIO FRAME COLORS



MARRONE
BROWN
RAL 8017



NERO
BLACK
RAL 9005



ALLUMINIO
ALUMINIUM
RAL 9007



BIANCO
WHITE
RAL 9010





ANTIPANICO

Porta blindata per uscite di sicurezza.
Security door for emergency exit.

DESCRIZIONE DESCRIPTION

La porta ANTIPANICO adotta una particolare serratura che oltre al normale funzionamento a chiave, ha il maniglione per l'apertura rapida a spinta della porta. Premendo il maniglione la porta si apre anche se la serratura è chiusa non solo con lo scrocco ma anche con tutte le mandate.

The ANTIPANICO single-leaf armoured door has a special lock. The lock, besides working normally with a key, has a push-bar for quick opening of the door. Pushing on the push-bar the door opens even locked, not only with the latch but even when it is turned all the way.

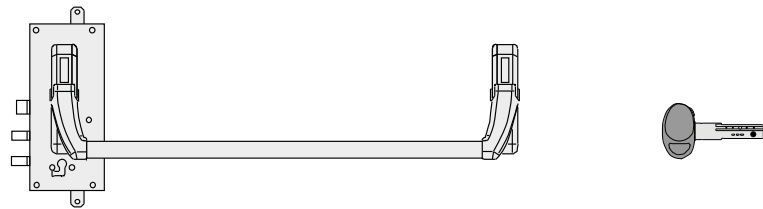

COLORI TELAIO FRAME COLORS

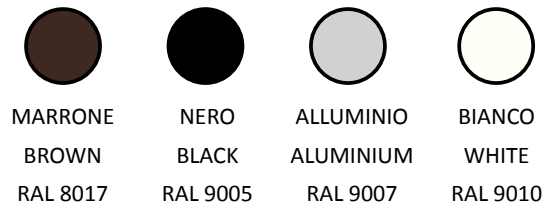

10 PUNTI DI CHIUSURA LOCK POINT

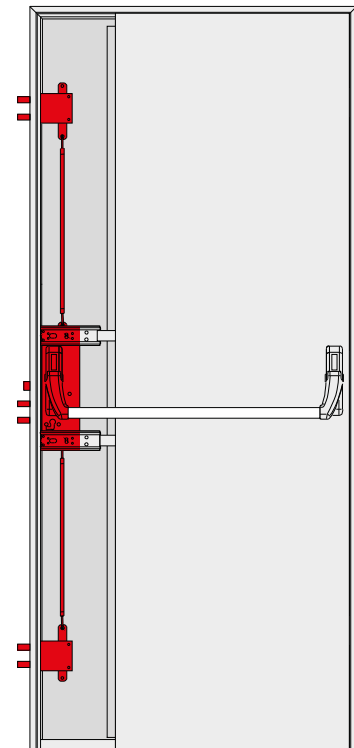

DATI TECNICI DI SERIE STANDARD TECHNICAL DATA

- Controtelaio in lamiera zincata
- Telaio profilato Tipo P1 regolabile, spessore 20/10 in acciaio verniciato con polveri poliestere
- Struttura perimetrale dell'anta in acciaio profilato 15/10, anta doppia lamiera 15/10 e 8/10 con rinforzi verticali interni a "Z", verniciata con polveri poliestere
- Serratura con Maniglione antipanico triplice a cilindro profilo europeo, protetto da defender antitrapano
- Punti di chiusura : n. 10 in acciaio ø18 mm
- Doppia guarnizione di battuta sull'anta
- Coibentazione interna dell'anta con EPS
- Tagliaspifferi con guarnizione multilabbro autolivellante
- Spioncino grandangolare
- Cerniere Registrabili in altezza
- Subframe made of galvanised sheet metal
- Frame P1 adjustable, 20/10 thick steel painted with polyester powders
- Perimeter structure of leaf in 15/10 steel profile, 15/10 and 8/10 double sheet metal, internal vertical reinforcements to "Z", painted with polyester powders
- Lock with anti-panic push-bar to europrofile cylinder with Defender
- Locking points : n. 10, made of steel ø18 mm
- Double gasket on the door
- Insulation inside door with EPS
- Draught proofing with self-levelling multi-lip gasket
- Peephole wide angle lens
- Adjustable hinges in height









3

CLASSE

FIRE 30 - FIRE 60

Porte blindate tagliafuoco.
Fire security doors.

DESCRIZIONE DESCRIPTION

- **FIRE 30** certificata secondo la norma CNVVF/CCI/UNI/9723 in classe di resistenza al fuoco REI 30 / RE 30
- **FIRE 60** certificata secondo la norma UNI EN 13501-2:2009 in classe di resistenza al fuoco EI₂ 60, EI₁ 45.
Possono essere utilizzate nell' edilizia residenziale, per l'edilizia ricettiva, hotel, residence e villaggi turistici.
- **FIRE 30** is certified according to the standard CNVVF/CCI/UNI/9723 for fire proof class REI 30 / RE30
- **FIRE 60** is certified according to the standard UNI EN 13501-2:2009 for fire proof class EI₂ 60, EI₁ 45.
They can be used for residential buildings, accommodation, hotels, residences and holiday resorts.

COLORI TELAIO FRAME COLORS

			
MARRONE BROWN RAL 8017	NERO BLACK RAL 9005	ALLUMINIO ALUMINIUM RAL 9007	BIANCO WHITE RAL 9010

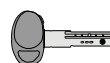
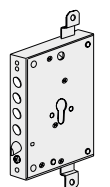

9 PUNTI DI CHIUSURA LOCK POINT

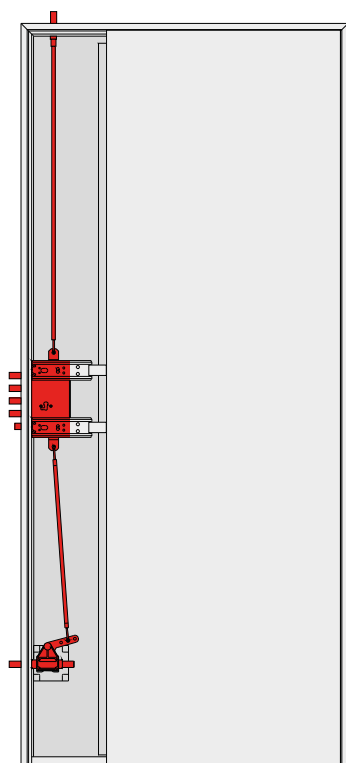

DATI TECNICI DI SERIE STANDARD TECHNICAL DATA

- Controtelaio in lamiera zincata
- Telaio profilato Tipo P1 regolabile , spessore 20/10 in acciaio verniciato con polveri poliestere
- Struttura perimetrale dell'anta in acciaio profilato 15/10, anta doppia lamiera 15/10 e 8/10 con rinforzi verticali interni a "Z" , verniciata con polveri poliestere
- Coibentazione dell'anta con materiale ignifugo
- Serratura a cilindro profilo europeo con protezione in lamiera al manganese
- Punti di chiusura : n. 9 in acciaio ø18 mm
- Doppia guarnizione di battuta sull'anta
- Guarnizione perimetrale termoespandente su quattro lati
- Tagliaspifferi con guarnizione multilabbro autolivellante
- Cerniere Registrabili in altezza
- Chiudi porta aereo
- Subframe made of galvanised sheet metal
- Frame P1 adjustable, 20/10 thick steel painted with polyester powders
- Perimeter structure of leaf in 15/10 steel profile, 15/10 and 8/10 double sheet metal, internal vertical reinforcements to "Z", painted with polyester powders
- Doors insulated with fireproof material
- Europrofile cylinder Lock with manganese sheet metal protection
- Locking points : n. 9, made of steel ø18 mm
- Perimeter intumescent gasket on four sides
- Draught proofing with self-levelling multi-lip gasket
- Adjustable hinges in height
- Door closers





SICURA MULTI CL

3

CLASSE

Il modello SICURA MULTI CL è abbinato al rivestimento della collezione ALLUMINIO.
The SICURA MULTI CL model is combined to the ALLUMINIUM collection panel.



10 PUNTI DI CHIUSURA LOCK POINT

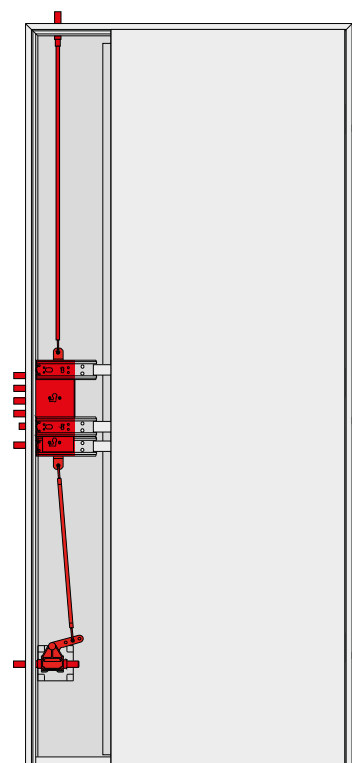
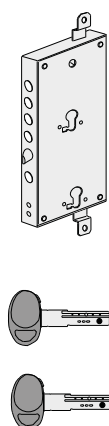

DATI TECNICI DI SERIE STANDARD TECHNICAL DATA

- Controtelaio in lamiera zincata
- Telaio profilato Tipo P1 regolabile , spessore 20/10 in acciaio verniciato con polveri poliestere
- Struttura perimetrale dell'anta in acciaio profilato 15/10, anta doppia lamiera 15/10 e 8/10 con rinforzi verticali interni a "Z" , verniciata con polveri poliestere
- Serratura MULTIFUNZIONE, parte superiore: cilindro a profilo europeo protetto da defender antitrapano; parte inferiore: cilindro a profilo europeo con protezione totale della serratura in lamiera al manganese
- Punti di chiusura : n. 10 in acciaio ø18 mm
- Doppia guarnizione di battuta sull'anta
- Coibentazione interna dell'anta con EPS
- Tagliaspifferi con guarnizione multilabbro autolivellante
- Spioncino grandangolare
- Cerniere Registrabili in altezza
- Subframe made of galvanised sheet metal
- Frame P1 adjustable, 20/10 thick steel painted with polyester powders
- Perimeter structure of leaf in 15/10 steel profile, 15/10 and 8/10 double sheet metal, internal vertical reinforcements to "Z", painted with polyester powders
- Upper Lock : Europrofile cylinder with Defender
- Lower Lock : Europrofile cylinder with total protection of the manganese sheet metal lock
- Locking points : n. 10, made of steel ø18 mm
- Double gasket on the door
- Insulation inside door with EPS
- Draught proofing with self-levelling multi-lip gasket
- Peephole wide angle lens
- Adjustable hinges in height

COLORI TELAIO FRAME COLORS



MARRONE
BROWN
RAL 8017



NERO
BLACK
RAL 9005



ALLUMINIO
ALUMINIUM
RAL 9007



BIANCO
WHITE
RAL 9010





3

CLASSE

SICURA MULTI

Il modello SICURA MULTI è abbinato al rivestimento della collezione RIFLESSI.
The SICURA MULTI model is combined to the RIFLESSI collection panel.



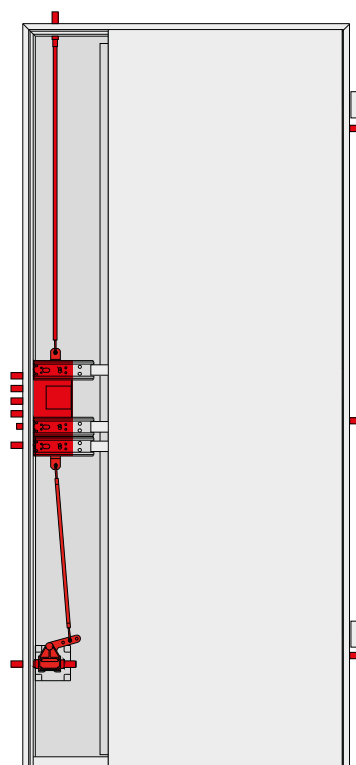
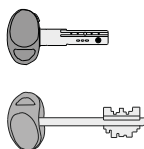
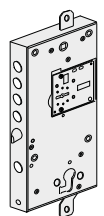

10 PUNTI DI CHIUSURA LOCK POINT



DATI TECNICI DI SERIE STANDARD TECHNICAL DATA

- Controtelaio in lamiera zincata
- Telaio profilato Tipo P1 regolabile, spessore 20/10 in acciaio verniciato con polveri poliestere
- Struttura perimetrale dell'anta in acciaio profilato 15/10, anta doppia lamiera 15/10 e 8/10 con rinforzi verticali interni a "Z", verniciata con polveri poliestere
- Serratura MULTIFUNZIONE, parte superiore: a doppia mappa; parte inferiore: cilindro a profilo europeo con protezione totale della serratura in lamiera al manganese
- Punti di chiusura : n. 10 in acciaio ø18 mm
- Doppia guarnizione di battuta sull'anta
- Coibentazione interna dell'anta con EPS
- Tagliaspifferi con guarnizione multilabbro autolivellante
- Spioncino grandangolare
- Cerniere Registrabili in altezza
- Subframe made of galvanised sheet metal
- Frame P1 adjustable, 20/10 thick steel painted with polyester powders
- Perimeter structure of leaf in 15/10 steel profile, 15/10 and 8/10 double sheet metal, internal vertical reinforcements to "Z", painted with polyester powders
- Upper lock : double-bitted
- Lower lock : Europrofile cylinder with total protection of the manganese sheet metal lock
- Locking points : n. 10, made of steel ø18 mm
- Double gasket on the door
- Insulation inside door with EPS
- Draught proofing with self-levelling multi-lip gasket
- Peephole wide angle lens
- Adjustable hinges in height

COLORI TELAIO FRAME COLORS

			
MARRONE BROWN RAL 8017	NERO BLACK RAL 9005	ALLUMINIO ALUMINIUM RAL 9007	BIANCO WHITE RAL 9010





SICURA CL

Il modello SICURA CL è abbinato al rivestimento della collezione PIANA ORIZZONTALE.
The SICURA CL model is combined to the PIANA ORIZZONTALE collection panel.

3
CLASSE



9 PUNTI DI CHIUSURA LOCK POINT

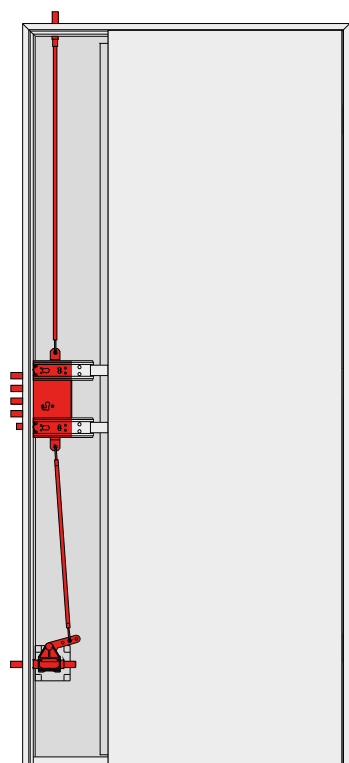
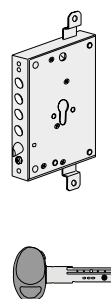

DATI TECNICI DI SERIE STANDARD TECHNICAL DATA

- Controtelaio in lamiera zincata
- Telaio profilato Tipo P1 regolabile , spessore 20/10 in acciaio verniciato con polveri poliestere
- Struttura perimetrale dell'anta in acciaio profilato 15/10, anta doppia lamiera 15/10 e 8/10 con rinforzi verticali interni a "Z" , verniciata con polveri poliestere
- Serratura a cilindro profilo europeo con protezione in lamiera al manganese e defender antitrapano
- Punti di chiusura : n. 9 in acciaio ø18 mm
- Doppia guarnizione di battuta sull'anta
- Coibentazione interna dell'anta con EPS
- Tagliaspifferi con guarnizione multilabbro autolivellante
- Spioncino grandangolare
- Cerniere Registrabili in altezza
- Subframe made of galvanised sheet metal
- Frame P1 adjustable, 20/10 thick steel painted with polyester powders
- Perimeter structure of leaf in 15/10 steel profile, 15/10 and 8/10 double sheet metal, internal vertical reinforcements to "Z", painted with polyester powders
- Europrofile cylinder Lock with Defender and with manganese sheet metal protection
- Locking points : n. 9, made of steel ø18 mm
- Double gasket on the door
- Insulation inside door with EPS
- Draught proofing with self-levelling multi-lip gasket
- Peephole wide angle lens
- Adjustable hinges in height

COLORI TELAIO FRAME COLORS



MARRONE
BROWN
RAL 8017



NERO
BLACK
RAL 9005



ALLUMINIO
ALUMINIUM
RAL 9007



BIANCO
WHITE
RAL 9010



3

CLASSE

SICURA DM

Il modello SICURA DM è abbinato al rivestimento della collezione METALLI.
The SICURA DM model is combined to the METALLI collection panel.



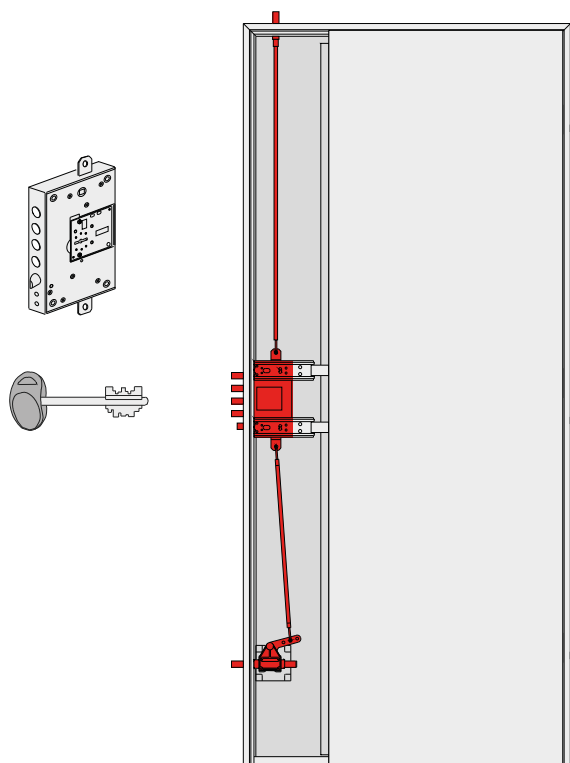

9 PUNTI DI CHIUSURA LOCK POINT



DATI TECNICI DI SERIE STANDARD TECHNICAL DATA

- Controtelaio in lamiera zincata
- Telaio profilato Tipo P1 regolabile , spessore 20/10 in acciaio verniciato con polveri poliestere
- Struttura perimetrale dell'anta in acciaio profilato 15/10, anta doppia lamiera 15/10 e 8/10 con rinforzi verticali interni a "Z" , verniciata con polveri poliestere
- Serratura a doppia mappa con protezione in lamiera al manganese
- Punti di chiusura : n. 9 in acciaio ø18 mm
- Doppia guarnizione di battuta sull'anta
- Coibentazione interna dell'anta con EPS
- Tagliaspifferi con guarnizione multilabbro autolivellante
- Spioncino grandangolare
- Cerniere Registrabili in altezza
- Subframe made of galvanised sheet metal
- Frame P1 adjustable, 20/10 thick steel painted with polyester powders
- Perimeter structure of leaf in 15/10 steel profile, 15/10 and 8/10 double sheet metal, internal vertical reinforcements to "Z", painted with polyester powders
- Double-bitted Lock with manganese sheet metal protection
- Locking points : n. 9, made of steel ø18 mm
- Double gasket on the door
- Insulation inside door with EPS
- Draught proofing with self-levelling multi-lip gasket
- Peephole wide angle lens
- Adjustable hinges in height

COLORI TELAIO FRAME COLORS

			
MARRONE BROWN RAL 8017	NERO BLACK RAL 9005	ALLUMINIO ALUMINIUM RAL 9007	BIANCO WHITE RAL 9010





DOPPIA DOMOTICA EASY - DOPPIA DOMOTICA SMART

Porte blindate con serratura elettronica motorizzata
Security door with electronic lock

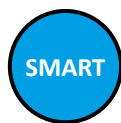

19 PUNTI DI CHIUSURA LOCK POINT

DATI TECNICI DI SERIE STANDARD TECHNICAL DATA

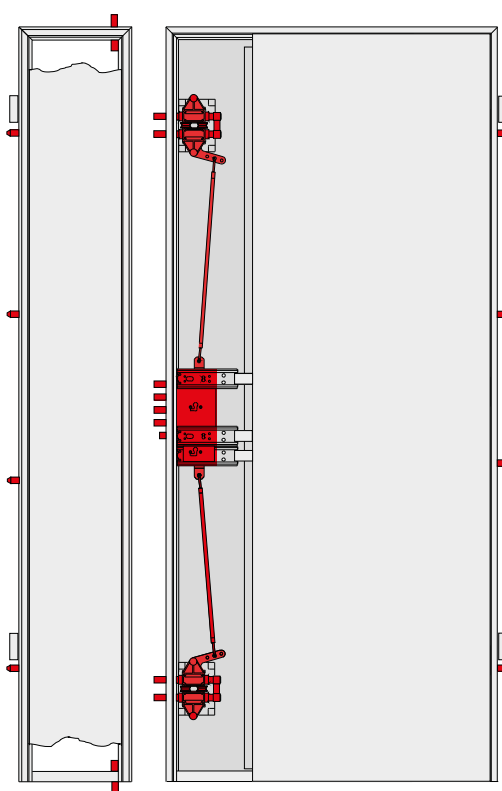
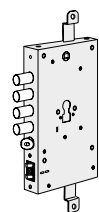

COLORI TELAIO FRAME COLORS



MARRONE
BROWN
RAL 8017



NERO
BLACK
RAL 9005



ALLUMINIO
ALUMINIUM
RAL 9007



BIANCO
WHITE
RAL 9010

- Controtelaio in lamiera zincata
- Telaio profilato Tipo P1 regolabile , spessore 20/10 in acciaio verniciato con polveri poliestere
- Struttura perimetrale dell'anta in acciaio profilato 15/10, anta doppia lamiera 15/10 e 8/10 con rinforzi verticali interni a "Z" , verniciata con polveri poliestere
- Serratura elettronica con apertura tramite chiave trasponder, tastiera numerica o lettore biometrico di impronta digitale e manualmente con cilindro a profilo europeo protetto con defender antitrapano
- Punti di chiusura : n. 19 in acciaio ø 18 mm
- Doppia guarnizione di battuta sull'anta
- Coibentazione interna dell'anta con EPS
- Tagliaspifferi con guarnizione multilabbro autolivellante
- Spioncino grandangolare
- Cerniere Registrabili in altezza
- Subframe made of galvanised sheet metal
- Frame P1 adjustable, 20/10 thick steel painted with polyester powders
- Perimeter structure of leaf in 15/10 steel profile, 15/10 and 8/10 double sheet metal, internal vertical reinforcements to "Z", painted with polyester powders
- Electronic lock opening by a transponder key, numerical keypad or biometric fingerprint reader and manually with Europrofile cylinder with Defender
- Locking points : n. 19, made of steel ø 18 mm
- Double gasket on the door
- Insulation inside door with EPS
- Draught proofing with self-levelling multi-lip gasket
- Peephole wide angle lens
- Adjustable hinges in height



DOPPIO GARANTE MULTI CL

Il modello DOPPIO GARANTE MULTI CL realizzato con la soluzione a vetro è abbinato al rivestimento della collezione MASSELLI.
The DOPPIO GARANTE MULTI CL model with glass, is combined to the MASSELLI collection panel.



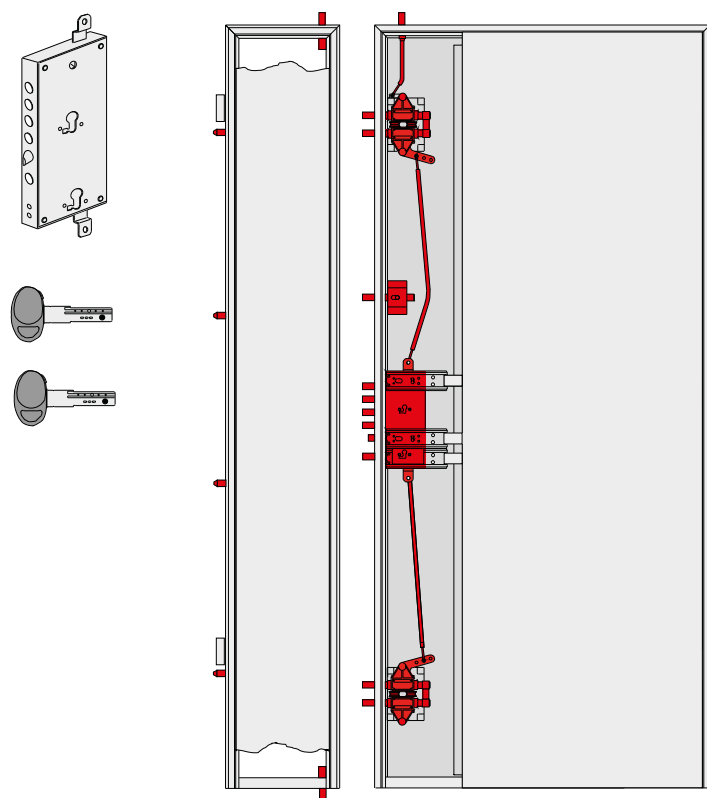

21 PUNTI DI CHIUSURA LOCK POINT



DATI TECNICI DI SERIE STANDARD TECHNICAL DATA

- Controtelaio in lamiera zincata
- Telaio profilato Tipo P1 regolabile , spessore 20/10 in acciaio verniciato con polveri poliestere
- Struttura perimetrale dell'anta in acciaio profilato 15/10, anta doppia lamiera 15/10 e 8/10 con rinforzi verticali interni a "Z" , verniciata con polveri poliestere
- Serratura MULTIFUNZIONE, parte superiore: cilindro a profilo europeo protetto da defender antitrapano; parte inferiore : cilindro a profilo europeo con protezione totale della serratura in lamiera al manganese
- Punti di chiusura : n. 21 in acciaio ϕ 18 mm
- Doppia guarnizione di battuta sull'anta
- Coibentazione interna dell'anta con EPS
- Tagliaspifferi con guarnizione multilabbro autolivellante
- Spioncino grandangolare
- Limitatore d'apertura
- Cerniere Registrabili in altezza
- Subframe made of galvanised sheet metal
- Frame P1 adjustable, 20/10 thick steel painted with polyester powders
- Perimeter structure of leaf in 15/10 steel profile, 15/10 and 8/10 double sheet metal, internal vertical reinforcements to "Z", painted with polyester powders
- Upper Lock : Europrofile cylinder with Defender
- Lower Lock : Europrofile cylinder with total protection of the manganese sheet metal lock
- Locking points : n. 21, made of steel ϕ 18 mm
- Double gasket on the door
- Insulation inside door with EPS
- Draught proofing with self-levelling multi-lip gasket
- Peephole wide angle lens
- Opening limiter
- Adjustable hinges in height

COLORI TELAIO FRAME COLORS

			
MARRONE BROWN RAL 8017	NERO BLACK RAL 9005	ALLUMINIO ALUMINIUM RAL 9007	BIANCO WHITE RAL 9010





DOPPIA DIFESA CL

Il modello DOPPIA DIFESA CL è abbinato al rivestimento della collezione PANTOGRAFATI.
The DOPPIA DIFESA CL model is combined to the PANTOGRAFATI collection panel.



20 PUNTI DI CHIUSURA LOCK POINT

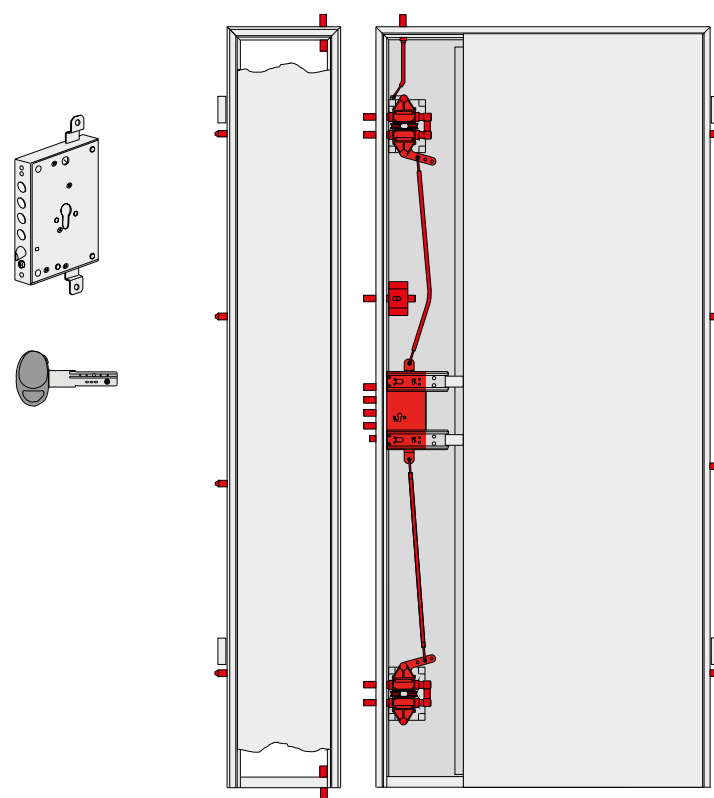

DATI TECNICI DI SERIE STANDARD TECHNICAL DATA

- Controtelaio in lamiera zincata
- Telaio profilato Tipo P1 regolabile , spessore 20/10 in acciaio verniciato con polveri poliestere
- Struttura perimetrale dell'anta in acciaio profilato 15/10, anta doppia lamiera 15/10 e 8/10 con rinforzi verticali interni a "Z" , verniciata con polveri poliestere
- Serratura a cilindro profilo europeo con protezione in lamiera al manganese e defender antitrapano
- Punti di chiusura : n. 20 in acciaio \varnothing 18 mm
- Doppia guarnizione di battuta sull'anta
- Coibentazione interna dell'anta con EPS
- Tagliaspifferi con guarnizione multilabbro autolivellante
- Spioncino grandangolare
- Limitatore d'apertura
- Cerniere Registrabili in altezza
- Subframe made of galvanised sheet metal
- Frame P1 adjustable, 20/10 thick steel painted with polyester powders
- Perimeter structure of leaf in 15/10 steel profile, 15/10 and 8/10 double sheet metal, internal vertical reinforcements to "Z", painted with polyester powders
- Europrofile cylinder Lock with Defender and with manganese sheet metal protection
- Locking points : n. 20, made of steel \varnothing 18 mm
- Double gasket on the door
- Insulation inside door with EPS
- Draught proofing with self-levelling multi-lip gasket
- Peephole wide angle lens
- Opening limiter
- Adjustable hinges in height

COLORI TELAIO FRAME COLORS

			
MARRONE BROWN RAL 8017	NERO BLACK RAL 9005	ALLUMINIO ALUMINIUM RAL 9007	BIANCO WHITE RAL 9010



DOPPIO ARCO CL

Il modello DOPPIO ARCO CL è abbinato al rivestimento della collezione PANTOGRAFATI.
The DOPPIO ARCO CL model is combined to the PANTOGRAFATI collection panel.

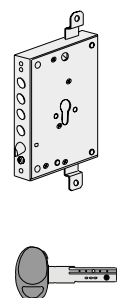

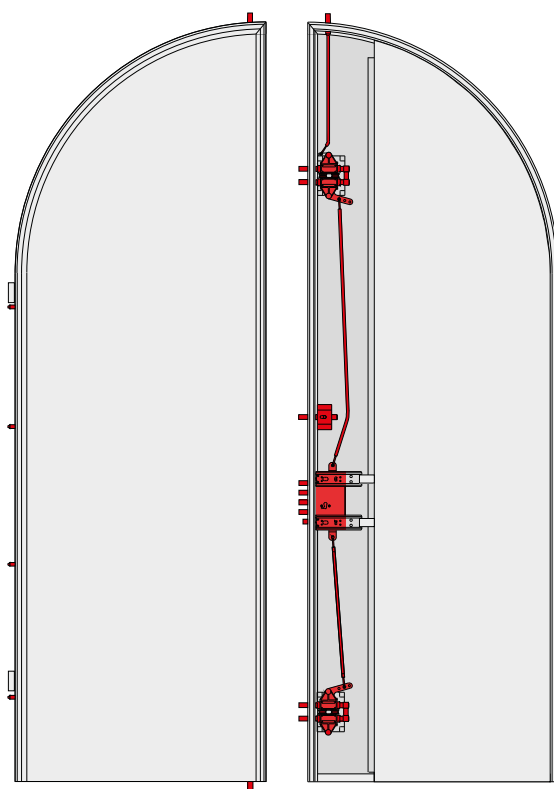

20 PUNTI DI CHIUSURA LOCK POINT



DATI TECNICI DI SERIE STANDARD TECHNICAL DATA

- Controtelaio in lamiera zincata
- Telaio profilato Tipo P1 regolabile , spessore 20/10 in acciaio verniciato con polveri poliestere
- Struttura perimetrale dell'anta in acciaio profilato 15/10, anta doppia lamiera 15/10 e 8/10 con rinforzi verticali interni a "Z" , verniciata con polveri poliestere
- Serratura a cilindro profilo europeo con protezione in lamiera al manganese e defender antitrapano
- Punti di chiusura : n. 20 in acciaio ø 18 mm
- Doppia guarnizione di battuta sull'anta
- Coibentazione interna dell'anta con EPS
- Tagliaspifferi con guarnizione multilabbro autolivellante
- Spioncino grandangolare
- Limitatore d'apertura
- Cerniere Registrabili in altezza
- Subframe made of galvanised sheet metal
- Frame P1 adjustable, 20/10 thick steel painted with polyester powders
- Perimeter structure of leaf in 15/10 steel profile, 15/10 and 8/10 double sheet metal, internal vertical reinforcements to "Z", painted with polyester powders
- Europrofile cylinder Lock with Defender and with manganese sheet metal protection
- Locking points : n. 20, made of steel ø 18 mm
- Double gasket on the door
- Insulation inside door with EPS
- Draught proofing with self-levelling multi-lip gasket
- Peephole wide angle lens
- Opening limiter
- Adjustable hinges in height

COLORI TELAIO FRAME COLORS

			
MARRONE BROWN RAL 8017	NERO BLACK RAL 9005	ALLUMINIO ALUMINIUM RAL 9007	BIANCO WHITE RAL 9010



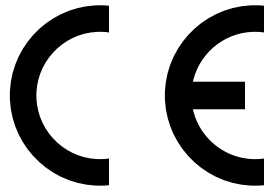

QUALITA'

i test e le prove per diventare EFFEPI®

Le porte EFFEPI® sono conformi alla normativa UNI EN 14351-1



CERTIFICAZIONE INGLESE

BASIC SECURITY ACCORDING TO STANDARD BS 6375-3:2009

Sulla base del test effettuato, dei risultati ottenuti e disposizioni della Norma BS 6375-3: 2009, il campione in prova presentato dalla società Blindato Effepi S.r.l. ha superato le prove specificate nell'allegato A della norma BS 6375-3:2009.

On the basis of the test performed, on the basis of the results obtained and on the basis of the provisions of standard BS 6375-3:2009, the sample under test submitted by the company Blindato Effepi S.r.l. has passed the basic security tests specified in the annex A of standard BS 6375-3:2009 itself.

RESISTENZA ALL'EFFRAZIONE BURGLAR RESISTANCE

UNI ENV 1627 - UNI ENV 1628
UNI ENV 1629 - UNI ENV 1630

Con tali prove vengono valutate le caratteristiche di resistenza all'effrazione delle porte blindate sotto le azioni di carico statico, carico dinamico e attacco manuale compiute da scassinatori con gli attrezzi e i congegni indicati nei metodi di prova.

Alla fine delle prove vengono rilevati il livello di degrado del serramento e il tempo occorsi per aprirlo e viene stabilita la classe di resistenza del serramento seguendo le indicazioni fornite dalle tabelle della norma UNI ENV 1627 - 30. Maggiore è il valore certificato, maggiore sarà la resistenza del serramento ai tentativi di scassinamento; la norma infatti assegna al serramento una classe con un valore che cresce con l'aumentare della resistenza su una scala da 1 a 6.

Le classi indicate per un uso in ambito residenziale sono:

- CLASSE 2 (abitazioni a basso rischio)
- CLASSE 3 (abitazioni con un rischio medio)
- CLASSE 4 (adatte ad abitazioni con un elevato rischio)

Le classi 5 e 6 sono riservate a serramenti da utilizzare in ambienti prettamente non residenziali e ad altissimo rischio di intrusione (banche, istituzioni, gioiellerie, ecc).

With this test can be valuated the safety characteristic for a security door under static load, dynamic load and manual attack from the burglars with tools and devices used in the security test. At the end of the test, in order to establish the resistance class for the door, are pointed up the level of the degradation of the door and the time to open it. Greater is the value, biggest is the resistance of the door (range from 1 to 6).

For the residential are:

- CLASS 2 is the low risk
- CLASS 3 is the medium risk
- CLASS 4 high risk

The classes with 5 and 6 are not reserved for residential but are suitable for banks, jewellers, etc, with a very high risk of intrusion.



PERMEABILITA' ALL'ARIA AIR PERMEABILITY



UNI EN 1026 - UNI EN 12207

Porte EFFEPI = CLASSE 4

E' la caratteristica di un serramento chiuso di lasciare filtrare aria nel caso di una differenza di pressione tra l'interno e l'esterno. La classificazione viene valutata secondo la norma UNI E 12207, che prevede quattro classi di prestazione (1,2,3,4). La classe massima, che cioè prevede le infiltrazioni di aria più ridotte è la classe 4.

EFFEPI doors = CLASS 4

A characteristic of a closed windows to leave air filtering in case of pressure difference between inside and outside. The classification is evaluated according to the UNI 12207 E, which provides four classes of performance (1,2,3,4). The top class is 4, which is when the smallest quantity of air is filtered.

TRASMITTANZA TERMICA THERMAL TRANSMISSION



UNI EN 10077/1

Porte EFFEPI = Ud da 1.5 a 0,85 W/mqK

Il coefficiente di trasmittanza termica (UD) indica quanta energia (calore/refrigerazione) disperde il serramento attraverso la propria superficie. Minore è il valore di trasmittanza termica maggiore è la capacità della porta blindata di mantenere il calore nell'ambiente.

EFFEPI doors = Ud from 1.5 to 0,85 W/mqK

The thermal transmittance coefficient (UD), indicates how many energy (warmth / refrigeration) waste the window through its surface. Less the thermal transmittance coefficient is, more is the capacity for the security door to keep the warm.

TENUTA ALL'ACQUA WATER TIGHTNESS



UNI EN 1027 - UNI EN 12208

Porte EFFEPI = CLASSE 6A

E' la capacità di un serramento di impedire infiltrazioni d'acqua sotto l'azione di una pressione differenziale tra interno ed esterno analoga a quella della prova di permeabilità all'aria. La norma UNI EN 12208 prevede nove classi raggiungibili dal serramento abbinato alla lettera A corrispondente al metodo che variano dalla classe 1A alla classe 9A. La classificazione di tenuta all'acqua più elevata è la classe 9A, corrispondente a un serramento in grado di impedire infiltrazioni di acqua fino ad una velocità del vento pari a 600 Pa (circa 115 Km/h).

EFFEPI doors = CLASS 6A

It is the capacity to stop water infiltration caused by the difference between the pressure inside and externally as per the air permeability test. The UNI EN 12208 law, provides nine classes together A. The range is included between class 1A to class 9A. The top class is 9A and it corresponds to a window able to stop water infiltration up to a speed of wind equal to 600 Pa (around 115 km/h).

ACUSTICA ACOUSTICS



UNI EN ISO 717-1:2007
UNI/TR 11175:2005

E' la capacità di un elemento di edificio di fornire protezione passiva contro il rumore, tutelando gli ambienti interni delle abitazioni. Il valore che evidenzia il potere fonoisolante del prodotto è espresso in decibel (dB) e si indica con R_w (C;Ctr). Nelle porte blindate EFFEPI è possibile l'inserimento di appositi kit prestazionali (-37dB , -41dB , -44dB) per migliorare il confort acustico standard di -35 dB.

It's the capacity of a building element to provide passive protection against noise, protecting the inside of house. The value is indicated in decibel (dB) and it's indicated as R_w (C, Ctr). In the BLINDATO EFFEPI security doors is possible to add special performance kit (-37db, -41db, -44db) to improve the standard acoustic level -35db.

RESISTENZA AL VENTO WIND RESISTANCE



UNI EN 12211 - UNI EN 12210

Porte EFFEPI = CLASSE B3

E' la capacità di un serramento, sottoposto a forti pressioni e/o depressioni, come quelle causate dal vento, di mantenere una deformazione ammissibile, di conservare le sue proprietà e di salvaguardare la sicurezza degli utenti. Secondo la norma UNI EN 12210 l'infisso può essere classificato in cinque classi per la pressione del vento (1,2,3,4,5) e tre classi per la freccia relativa frontale (A,B,C) il cui abbinamento fornisce la classificazione del serramento (C3, B5,A1, ecc.). La classe che prevede le pressioni massime è la classe 5, mentre la classe che prevede la deformazione ammissibile migliore (e quindi più limitata) è la classe C.

EFFEPI doors = CLASS B3

It's the capacity for a window, submitted to a strong pressure and /or depression as per the ones caused by the wind, to maintain a permissible deformation, to maintain the main characteristic and grant the safety of users. Followings the law UNI EN 12210, the window could be classified in 5 classes for the wind pressure (1,2,3,4,5) and three classes for the deformation front (A, B, C). Whose combination provides the window classification (C3, B5, A1 etc). The class that provide the maximum pressure is the class 5 while the class who provides the best permissible deformation (therefore more limited) is the class C.

RESISTENZA AL FUOCO FIRE-RESISTANCE RATING



UNI EN 13501-2:2009 Porte EFFEPI = EI 60
CN VVF/CCI UNI9723: Porte EFFEPI = RE/REI 30
OMOLOGAZIONE mercato svizzero = VKF Brandschutzanwendung Nr. 26995

La denominazione EI o REI indica la capacità della porta di conservare, per un determinato tempo, le caratteristiche di stabilità, tenuta e isolamento termico in presenza di condizioni di incendio e temperatura elevata.

The name RE or REI indicates the door capability to preserve its features in the presence of fire for set times of stability, seal and heat insulation characteristics in a determined period of time in the presence of fire conditions and high temperature.



SICUREZZA

la protezione giusta nel posto giusto

I NOSTRI SUGGERIMENTI PER UNA SCELTA MIRATA OUR TIPS FOR THE BEST CHOICE



Le porte blindate Effepi® rispondono a 3 Classi di sicurezza fra le quali ogni persona o famiglia può riconoscere quella più confacente alla propria tutela in rapporto al tipo di immobile e alla sua ubicazione e al grado di sicurezza che si intende ottenere:

Classe 2 alloggi in condomini in zone con bassa delinquenza o seconde abitazioni (persone o giovani coppie per un grado di protezione base)

Classe 3 alloggi in palazzine plurifamiliari o case singole in zone centrali (buona sicurezza per un'efficace protezione dell'intera famiglia)

Classe 4 case isolate, ville importanti situate in posizioni poco trafficate (persone o nuclei famigliari che necessitano di un grado di protezione elevato).

Effepi® armoured doors meet 3 Security Categories among which each person or family can find the most suited to their own protection in relation to the type of property and its location and the level of security desired:

Class 2 homes in apartment buildings in areas with low delinquency or holiday homes (people or young couples for a basic level of protection)

Class 3 homes in multi-family buildings or single houses in central areas (good security for the effective protection of the entire family)

Class 4 isolated houses, important villas located in areas with little traffic (people or families who require a high degree of protection).

le classi **2 3 4**

CLASSE 2

CLASSE DI SICUREZZA SECONDO LA NORMATIVA EUROPEA UNI ENV 1627

Lo scassinatore occasionale cerca di forzare la finestra, la porta o la chiusura oscurante usando attrezzi semplici, per esempio cacciaviti, tenaglie, cunei.
Porta per abitazioni o uffici.

The occasional burglar tries to force the window, door or black out screening using simple tools, such as screwdrivers, pliers, wedges.
Door for homes or offices



CLASSE 3

CLASSE DI SICUREZZA SECONDO LA NORMATIVA EUROPEA UNI ENV 1627

Lo scassinatore tenta di entrare usando in aggiunta un cacciavite e un piede di porco.
Porta montata in appartamenti, uffici, villette con alto rischio di furto.

The burglar attempts to enter also using a screwdriver and crowbar.
Door for flats, offices, detached homes at high burglary risks.



CLASSE 4

CLASSE DI SICUREZZA SECONDO LA NORMATIVA EUROPEA UNI ENV 1627

Lo scassinatore esperto usa in aggiunta seghe, martelli, accette, scalpelli e trapani portatili a batteria.
Porta per banche, oreficerie, laboratori.

The expert burglar also uses saws, hammers, hatchets, chisels, and cordless batter-powered drills.
Doors for banks, jewellery shops, workshops.



ACCESSORI e KIT

oltre la sicurezza, il comfort

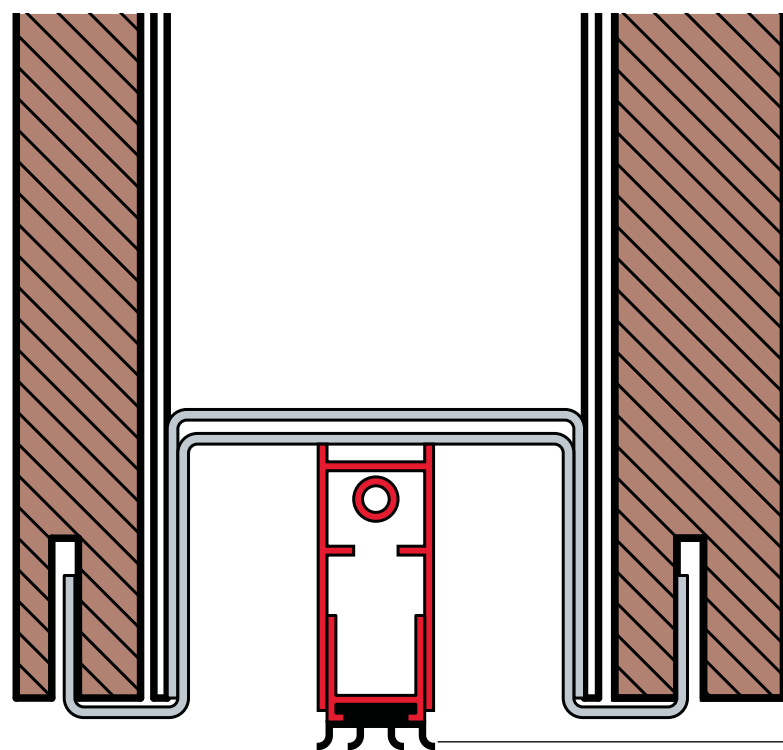

TAGLIASPIFFERO DRAFT PROOFING

È composto da un sistema di discesa di guarnizione mobile per impedire il passaggio di aria a porta chiusa. Adatto anche per soglia con battuta.

It is composed of a moving seal that prevents the air flow when the door is closed.

It is suitable also for sloped profile sills.

COIBENTAZIONE INSULATION

Ottenuta con pannelli in EPS o lana di roccia inseriti all'interno della doppia lamiera dell'anta, garantisce un buon isolamento termoacustico.

Per incrementare ulteriormente l'abbattimento acustico è possibile corredare la porta con appositi kit di differente grado di isolamento: -37 dB, -41dB, -44dB.

The thermal and sound insulation is guaranteed by inserting EPS or mineral wool panels in the space between the double sheet metal of the door leaf. To further increase the noise reduction the door can be fitted with a special kit for different degrees of sound insulation: -37 dB, -41dB, -44dB.

Pavimento
Floor

DOPPIA GUARNIZIONE **DOUBLE SEAL**

Elemento elastico di tenuta, inserito tra anta e telaio.
Questo accorgimento, che già di per sé costituisce una barriera contro aria e rumori, raddoppia la sua efficacia grazie all'inserimento di una seconda guarnizione.

Elastic seal that fills the space between the door leaf and the frame.
This measure, which in itself acts as a barrier against air and noise, doubles its effectiveness thanks to the inclusion of a second seal.

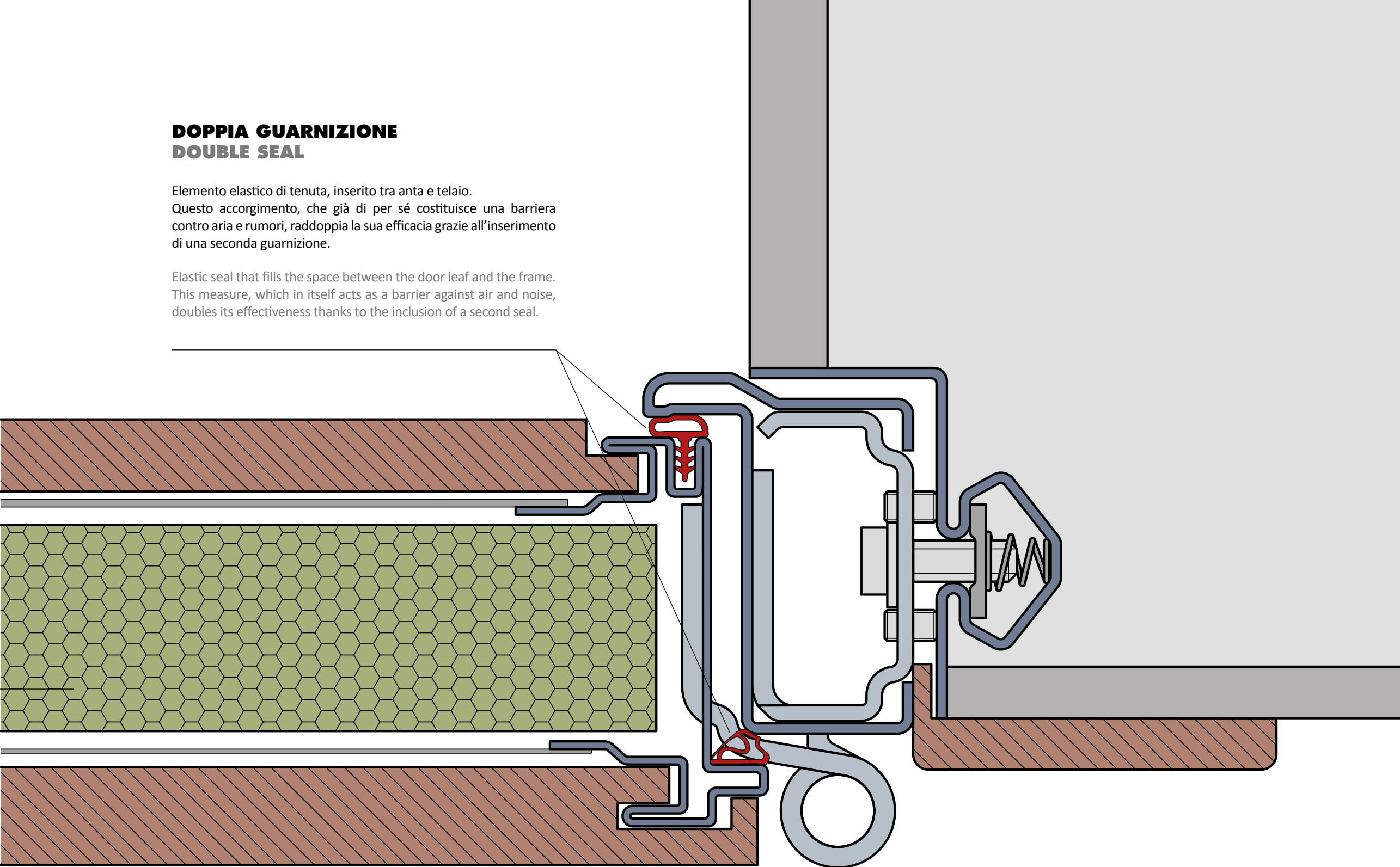

KIT SCUDO TERMICO

0,85W/m²K

COEFFICIENTE RAGGIUNTO

PARI A 0,85 W/m²K

Effepi® ha introdotto il nuovo kit denominato “Scudo termico”, caratterizzato da un nuovo sistema di coibentazione del rivestimento interno ed esterno realizzato utilizzando EPS ad alta densità; a ciò si aggiunge l’utilizzo di nuovi coprifili esterni avvolgenti e una completa coibentazione dell’anta e del telaio. Significativo il miglioramento delle prestazioni e dei valori della trasmittanza termica; questo nuovo kit permette infatti di raggiungere coefficienti pari a 0,85 W/m²K, nella soluzione con pannello esterno in legno da 14mm e pannello interno in legno da 21mm.

L’adozione di questo nuovo materiale isolante, inserito sotto i rivestimenti, l’utilizzo di nuovi coprifili esterni avvolgenti e il totale riempimento del telaio con lana di roccia ad alta densità, se da un lato permettono di ottenere una porta altamente performante a livello termico, dall’altro ne migliorano sensibilmente anche il confort acustico.

Effepi® introduced the new kit called “Thermal shield”, characterized by a new system of insulation of the internal and external panel, made using high density EPS, and besides this the use of new wrapped external frames and a full insulation of the door and the frame.

Significant improvement in performance and values of thermal transmittance, with this new kit you can reach thermal transmittance coefficients equal to 0.85 W / m² K (with 14 mm wood external panel and 21mm wood internal panel).

The adoption of this new insulating material, under the coatings, the use of new wrapped external frames and the total filling of the frame with high density rock wool improve thermal and acoustic performance.

KIT ACUSTICA SOUND INSULATION KIT

Inserendo appositi materiali tra le due lamiere dell’anta e nel telaio (lana di roccia, poliestic adesivo), e uno speciale tagliaspiffero, si possono ottenere diversi livelli di insonorizzazione.

La coibentazione interna è già di per sé un isolante acustico, con standard base di -35 decibel.

Grazie ai nostri kit, questo valore può essere incrementato a -37dB, -41dB, fino a un massimo di -44dB.

Inserting special materials between the double sheet metal of the door leaf and in the frame (mineral wool panels, poliestic adhesive), and a special draft proofing, it is possible to obtain different levels of soundproofing.

The internal insulation is in itself a sound insulation, with basic standards of -35 decibels. With our kits, this value can be increased to -37dB, -41dB, up to a maximum of -44dB.

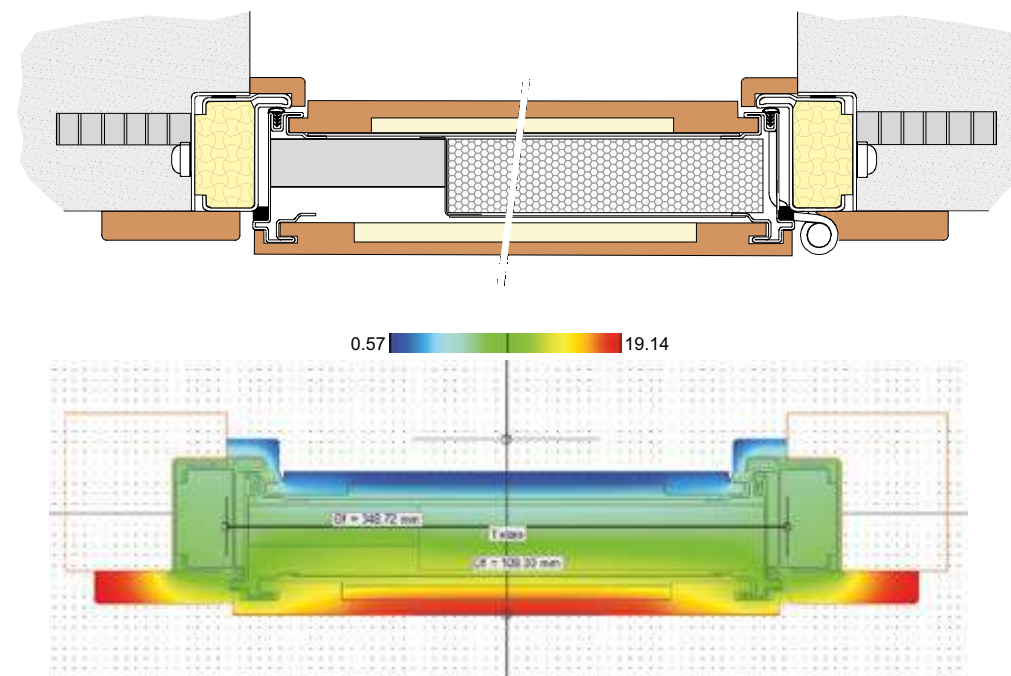

ACCESSORI e KIT

dettagli importanti che fanno la differenza



KIT ACQUA ARIA VENTO KIT WATER AIR WIND

Il kit garantisce una completa sigillatura della porta chiusa, evitando infiltrazione di elementi atmosferici. Composto da una particolare soglia in alluminio sagomata, da un profilato *acquastop* con guarnizione a tre camere (collocato nella parte inferiore) e da elementi di raccordo con le guarnizioni perimetrali dell'anta, ha lo scopo di formare **un sistema di tenuta integrale sui quattro lati della porta**. Il kit è stato testato presso l'Istituto Giordano - Rapporto di Prova N. 266076/4948/CPD del 18.02.2010.

The air-water-wind kit to seal the door closed to prevent the infiltration of the elements inside the house. The kit includes a particular aluminium shaped threshold, a bordered water-stop with special gasket (at the bottom of the door) and special material between the bordered water-stop and the perimeter gasket on the door. Everything thought with the aim to seal the door in all its 4 sides.

The kit has been tested at the Istituto Giordano - Test Report No. 266076/4948/ CPD of 18.02.2010







I RIVESTIMENTI

colori e materiali per ogni esigenza

COLLECTIONS EXTERIOR

DESIGN
MATERIE
MASSELLO
PANTOGRAFATI
ALLUMINIO
PVC

COLLECTIONS INTERIOR

DESIGN
LUXURY
WALL
PIANA

PROPONI IL TUO PROGETTO SUBMIT YOUR PROJECT

Le soluzioni estetiche che presentiamo in questa sezione rappresentano solo alcuni esempi fra i tanti possibili. Effepi® ha sempre il piacere di accogliere progetti originali di architetti e designer che intendono proporre il loro punto di vista.

The aesthetic solutions that we present in this section are just a few examples among many. Effepi® is always pleased to welcome original projects of architects and designers who wish to propose their point of view.

EFFEPI® LO REALIZZA EFFEPI® WILL CREATE IT

Esperienza, versatilità produttiva, propensione all'innovazione contraddistinguono Effepi®. Con queste credenziali, i nostri tecnici valuteranno la fattibilità di progetti originali, offrendo completa collaborazione per garantire il miglior risultato.

Experience, production versatility, propensity towards innovation all distinguish Effepi®. With these credentials, our technicians will evaluate the feasibility of original projects, offering full cooperation to ensure the best result.



I RIVESTIMENTI

colori e materiali per ogni esigenza

DESIGN DESIGN

Caratterizzata da un'impronta formale contemporanea nello stile e nei materiali impiegati, la **Collezione Design** è proposta in tre versioni:

- **TRATTO** superfici monocrome solcate da morbide linee, per un gioco di chiaroscuro dall'eleganza essenziale
- **LINEA** il rivestimento in legno o laccato accoglie inserti sottili di metallo in vibranti abbinamenti di luce e colore
- **METALLI** le qualità materiche di acciaio inox e corten, esaltato da specifici trattamenti, disegnano superfici dal deciso impatto espressivo

Characterized by a formal contemporary imprint in the style and the materials used, the **Design collection** is available in three versions:

- **TRACT** monochromatic surfaces crossed by soft lines, for a dynamic effect of light and shade of essential elegance
- **LINE** the wooden or lacquered coating accommodates thin metal inserts in vibrant combinations of light and colour
- **METALS** the qualities of stainless steel and corten, enhanced by specific treatments, design surfaces with an important expressive impact

MATERIE MATERIE

Come manufatti di remota provenienza, i rivestimenti della **Collezione Materie** si presenta con tre differenti linee ispirate alla natura:

- **PIETRE** composte da sottili strati di pietra, le superfici integrano l'effetto di solidità della materia, con l'eleganza dei suoi cangianti cromatismi
- **TERRE** frutto di accurate lavorazioni manuali, nuove suggestioni vengono plasmate in rivestimenti dalla spiccata personalità
- **CERAMIC** realizzati in collaborazione con l'azienda produttrice, i rivestimenti in Kerlite, oltre alla palese bellezza della materia, offrono caratteristiche uniche per solidità e leggerezza. Queste sottili lastre di gres porcellanato raggiungono formati fino a 3 metri x 1, senza soluzione di continuità.

As artefacts of remote origin, the **Materials Collection** panels are available in three different lines inspired by nature:

- **STONE** composed of thin layers of stone, the surfaces complement the effect of the solidity of the material, with the elegance of its iridescent colours
- **EARTH** the result of careful craftsmanship, new ideas are moulded in panels with outstanding personality
- **CERAMIC** produced in cooperation with the manufacturer, the Kerlite panels, besides the obvious beauty of the material, offer unique features of strength and lightness. These thin porcelain stoneware tiles reach sizes up to 3 meters x 1, and are seamless.

COLLECTIONS EXTERIOR

DESIGN
MATERIE
MASSELLO
PANTOGRAFATI
ALLUMINIO
PVC

MASSELLO SOLID WOOD

Materiale intramontabile per solidità, bellezza e versatilità estetica, il legno massello supera ogni moda e tendenza. Eccellenza dei rivestimenti Effepi®, le lavorazioni vengono improntate al totale rispetto della materia esaltandone l'integrità del disegno delle fibre e dei relativi accostamenti cromatici.

Sono infatti queste le caratteristiche che fanno di ogni porta blindata in massello - in tutte le essenze proposte - un esemplare unico e irripetibile: materia 'viva' che vive oltre il tempo.

Timeless material for strength, beauty and aesthetic versatility, solid wood exceeds all fashion and trends. Excellence among Effepi® panels, the processes are based on the total respect of the material by enhancing the integrity of the design of the fibres and of their colour combinations.

These are the characteristics that make each armoured door in solid wood - in all types proposed a unique and unrepeatable product: material that is 'alive' and lives beyond time.





PANTOGRAFATI **PANTOGRAPH PANELS**

Realizzati in multistrato marino di Okoumè o in MDF idrofugo (Medium Density Fiber), entrambi i materiali, seppur con differenti caratteristiche, garantiscono solidità e stabilità al rivestimento, offrendo il miglior supporto ai processi di lavorazione e di finitura.

Proposti in un ampio catalogo di modelli, i pannelli pantografati segnano il sottile confine fra classicità e modernità: condizione ideale per una scelta estetica che dialoga spontaneamente sia con l'architettura contemporanea sia con quella di tradizione.

Made of multi-layer marine type Okoumè or water-repellent MDF (Medium Density Fibre), both materials, albeit with different characteristics, guarantee strength and stability to the panel, providing the best support for processing and finishing operations.

Available in a wide range of models, pantographed panels mark the fine line between classical and modern: ideal condition for an aesthetic choice that spontaneously communicates with contemporary architecture and tradition.

ALLUMINIO **ALUMINIUM**

Rivestimenti dalla spiccata impronta classica, la **Collezione Alluminio** unisce alle molteplici varianti di disegno e colori, eccellenti requisiti tecnici. Primo fra tutti la struttura 'a sandwich', composta sui due lati da lastre in alluminio. Il nucleo è coibentato con schiuma rigida in piral che oltre a costituire un ottimo isolante termico, ha caratteristiche di idrorepellenza particolarmente indicate per esterno. Queste proprietà, oltre a quella di speciali verniciature ad elevate temperature, ne fanno un pannello solido, stabile, che non richiede alcuna manutenzione.

Panels with a strong classical imprint, the **Aluminium Collection** combines various design and colours with excellent technical requirements. First and foremost the 'sandwich' structure, composed of aluminium plates on both sides. The core is insulated with rigid foam in piral that besides being an excellent thermal insulator, is water repellent and particularly suitable for outdoors. These properties, in addition to that of special high temperature paint work, make it a solid, stable pane, which does not require any maintenance.

PVC

Scelta economicamente vantaggiosa, ma non per questo banale, le porte blindate con rivestimento in PVC sono solide, idrorepellenti, adatte sia per interni che per esterni. Proposte in un'ampia gamma di stili, colori e finiture, possono essere in versione 'cieca' o a vetro, e non richiedono alcuna manutenzione.

Cost-effective choice, but by no means trivial, armoured doors with PVC panels are solid, water-resistant, suitable for both indoors and outdoors. Offered in a wide range of styles, colours and finishes, they can be 'blind' or glass doors, and require no maintenance.





COLLECTIONS INTERIOR

DESIGN
ELITE
WALL
PIANA

DESIGN

Caratterizzata da un'impronta formale contemporanea nello stile e nei materiali impiegati, la **Collezione Design** è proposta in tre versioni:

- **TRATTO** superfici monocrome solcate da morbide linee, per un gioco di chiaroscuro dall'eleganza essenziale
- **LINEA** il rivestimento in legno o laccato accoglie inserti sottili di metallo in vibranti abbinamenti di luce e colore
- **METALLI** le qualità materiche di acciaio inox e corten, esaltato da specifici trattamenti, disegnano superfici dal deciso impatto espressivo

Characterized by a formal contemporary imprint in the style and the materials used, the **Design collection** is available in three versions:

- **TRACT** monochromatic surfaces crossed by soft lines, for a dynamic effect of light and shade of essential elegance
- **LINE** the wooden or lacquered coating accommodates thin metal inserts in vibrant combinations of light and colour
- **METALS** the qualities of stainless steel and corten, enhanced by specific treatments, design surfaces with an important expressive impact

I RIVESTIMENTI

colori e materiali per ogni esigenza

ELITE

Con quattro linee di alta gamma, nella **Collezione Elite**, Effepi® indirizza la sua ricerca estetica sui rivestimenti, verso soluzioni di autentico prestigio:

- **INTARSI** riscoprendo la sapiente tradizione dell'ebanisteria, le superfici in tranciato di legno accostano campiture a vena verticale e orizzontale, per ottenere rivestimenti che si distinguono come veri e propri complementi d'arredo
- **PREZIOSI** su legno o lacca, cristalli in taglio a diamante punteggiano di luce le superfici, creando porte di raffinata personalità
- **RILIEVO** rivestimenti in bassorilievo con il sapore naturale del legno, per eleganti porte disegnate da luci e ombre
- **RIFLESSI** un semplice gioco di contrasto tra le superfici lucide laccate e quelle opache del legno naturale, per ottenere porte attraenti per forma e sostanza

With four high-end lines, the Effepi® **Elite collection** focuses its aesthetic research on the panels, towards authentic prestige solutions:

- **INLAY** rediscovering the cabinet-making wisdom of carpentry, surfaces arranged in sliced wooden veneer alternate strips with horizontal grain with others having vertical grain, to obtain panels that stand out as real furnishing accessories
- **PRECIOUS** of wood or lacquer surfaces, diamond cut crystals dot the surfaces with light, creating doors with refined personality
- **RELIEF** bas-relief panels with the natural taste of wood, for elegant doors designed on light and shadows
- **REFLECTIONS** a simple game of contrast between shiny lacquered and opaque surfaces of natural wood, to obtain attractive doors both in form and substance

WALL

Composta dalla linea **Terre e Carta da parati** questa collezione consente di ottenere superfici complanari e di continuità che integrano il rivestimento interna della porta con quella della parete circostante, per una scelta architettonica esclusiva e innovativa:

- **TERRE** frutto di accurate lavorazioni manuali, nuove suggestioni vengono plasmate in superfici dalla spiccata personalità
- **PAPER** realizzate con pannelli rivestiti in carta da parati, queste superfici segnano il gradito ritorno dello stile decorativo declinato in diversi segni e texture

Composed of the line **Earth and Wallpaper** this collection obtains planar and seamless surfaces integrating the inside panel of the door with that of the surrounding wall, for an exclusive and innovative architectural choice:

- **EARTH** the result of careful craftsmanship, new ideas are moulded into surfaces with outstanding personality
- **PAPER** made of wallpaper covered panels, these surfaces mark the welcome return of a declined decorative style in various symbols and textures

PIANA

Rivestimenti semplici ma ben strutturati, presentano superfici lisce con venatura legno orizzontale o verticale in gran parte già disponibili a magazzino

Simple but well structured panels, which have smooth surfaces with horizontal or vertical wood grain most already in stock





DESIGN

Tracce di forma e contrasti materici

COLLECTIONS EXTERIOR

1. Tratto
2. Linea
3. Metalli

Caratterizzata da un'impronta formale contemporanea nello stile e nei materiali impiegati, la **Collezione Design** è proposta in tre versioni che abbinano superfici monocrome incise, superfici in legno con inserti di metallo, superfici in acciaio inox e corten.

Characterized by a formal contemporary imprint in the style and the materials used, the **Design Collection** is available in three versions that combine monochrome engraved surfaces, wood surfaces with metal inserts, stainless steel surfaces and corten.





TRATTO

COLLECTION

PENELOPE



Rivestimento
laccato
tabacco con
incisioni

Tobacco
lacquered
panel with
incisions





Idoneo a zone protette da pensiline o portici (min. 1mt)



EXTERIOR

ULISSE

POLIFEMO

MEDUSA

EURIDICE



Rivestimento laccato melanzana con incisioni

Aubergine lacquered panel with incisions



Rivestimento laccato verde con incisioni

Green lacquered panel with incisions



Rivestimento laccato ecru con incisioni

Ecru lacquered panel with incisions



Rivestimento laccato ecru con incisioni

Ecru lacquered panel with incisions





LINEA DUE VERTICALE DUE ANTE



Rivestimento
in rovere
sbiancato
con inserti in
alluminio.

Bleached oak
panel with
aluminium
inserts



LINEA UNO ORIZZONTALE DUE ANTE



Rivestimento
laccato verde
tenue con
inserti in
alluminio.

Pale green
lacquered
panel with
aluminium
inserts





Idoneo a zone protette da pensiline o portici (min. 1mt)



EXTERIOR

LINEA DUE VERTICALE



Rivestimento in rovere grigio con inserti in alluminio.

Grey oak panel with aluminium inserts



LINEA UNO ORIZZONTALE



Rivestimento laccato crema con inserti in alluminio.

White cream lacquered panel with aluminium inserts



LINEA QUADRA



Rivestimento in noce nazionale con inserti in alluminio.

Italian walnut panel with aluminium inserts



LINEA DUE ORIZZONTALE



Rivestimento laccato melanzana con inserti in alluminio.

Aubergine lacquered panel with aluminium inserts



METALLI

COLLECTION

ALCIONE



Rivestimento
in acciaio
Cor-ten
con inserto
acciaio inox.

Cor-ten steel
panel with
stainless
steel insert



ATLAS



Rivestimento
in acciaio
Cor-ten
con inserto
acciaio inox.

Cor-ten steel
panel with
stainless
steel insert





Idoneo alla diretta esposizione del sole e intemperie



Idoneo a zone protette da pensiline o portici (min. 1mt)



EXTERIOR

POLARIS

POLARIS TEAK

PEGASO

ORIONE



Rivestimento laccato tabacco con inserto acciaio inox.

Tobacco lacquered panel with stainless steel insert



Rivestimento in teak con inserto acciaio inox.

Teak wood panel with stainless steel insert



Rivestimento in ciliegio con inserto acciaio inox.

Cherry wood panel with stainless steel insert



Rivestimento in wengè con inserto acciaio inox.

Wenge panel with stainless steel insert





MATERIE

plasmare, modellare, inventare

COLLECTIONS EXTERIOR

1. Pietre
2. Terre
3. Ceramic

Come manufatti di remota provenienza, i rivestimenti della **Collezione Materie** si presenta con tre differenti linee ispirate alla natura: le pietre, le terre, lo speciale gres porcellanato Kerlite. Rivestimenti che si distinguono con differenti personalità dall'inequivocabile eleganza di forma e sostanza.

As artefacts of remote origin, the **Materials Collection** are available in three different lines inspired by nature: stones, earths, the special Kerlite porcelain stoneware. Panels that are characterized by different personalities of unmistakable elegance in form and substance.





PIETRE

COLLECTION

CERVINO



Rivestimento
in pietra
Black e
inserto in
acciaio inox.

Black stone
panel and
stainless
steel insert





Idoneo a zone protette da pensiline o portici (min. 1mt)



EXTERIOR

MONTE ROSA



Rivestimento in pietra Sahara e inserto in acciaio inox.

Sahara stone panel and stainless steel insert



GRAN PARADISO



Rivestimento in pietra Multicolor e inserto in noce nazionale.

Multicolour stone panel and Italian walnut insert



TOFANE



Rivestimento in pietra Multicolor e inserto in acciaio inox.

Multicolour stone panel and stainless steel insert



MONTE BIANCO



Rivestimento in pietra Silver Shine e inserto in acciaio inox.

Silver Shine stone panel and stainless steel insert



TERRE

COLLECTION

SCIROCCO



Rivestimento
in biomalta
Ardesia con
inserto centrale
in biomalta
Grigio

BioMalta
Slate
panel with
central Grey
BioMalta
insert



PONENTE



Rivestimento
in biomalta
Nero

Black
BioMalta
panel

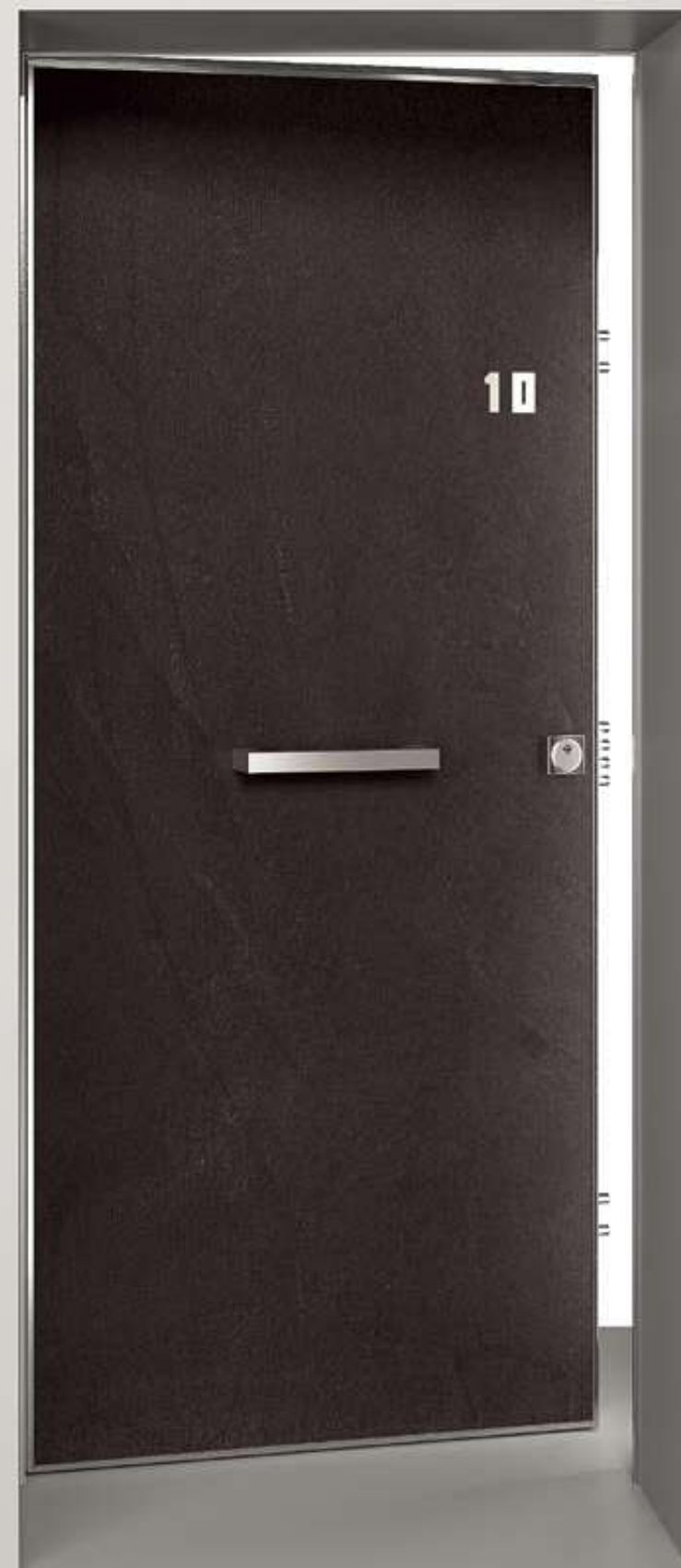



Idoneo a zone protette da pensiline o portici (min.1mt)



EXTERIOR

LIBECCIO



Rivestimento in biomalta Arenaria

Sandstone BioMalta panel



BORA



Rivestimento in biomalta Grigio e inserto in acciaio inox

Grey BioMalta panel and stainless steel insert



GARBINO



Rivestimento in biomalta Castagna e inserto in wengè

Chestnut BioMalta panel and wenge insert



CERAMIC

COLLECTION

ICON



Rivestimento
in Kerlite
Via Farini e
inserto in
acciaio inox

Kerlite Via
Farini panel
and stainless
steel insert



SUPERB



Rivestimento
in Kerlite
Pulpis Lux
e inserto in
acciaio inox

Kerlite Pulpis
Lux panel
and stainless
steel insert



SIGN



Rivestimento
in Kerlite
Calacatta Lux

Kerlite
Calacatta Lux
panel





Idoneo alla diretta
esposizione del sole
e intemperie



EXTERIOR

SNOB



Rivestimento
in Kerlite
Road e
inserti in
acciaio inox

Kerlite Road
panel and
stainless
steel inserts



Courtesy of Cotto d'Este







WOOD

le trame pregiate del legno

COLLECTIONS EXTERIOR

1. Plank
2. Masselli

Materiale intramontabile per solidità, bellezza e versatilità estetica, il legno massello è fra le eccellenze dei rivestimenti Effepi®: lavorazioni improntate al totale rispetto dei legni, per fare di ogni porta un esemplare unico e irripetibile: materia 'viva' che vive oltre il tempo.

Timeless material for strength, beauty and aesthetic versatility, Excellence among Effepi® panels. The processes are based on the total respect of the material. These are the characteristics that make each armoured door in solid wood - in all types proposed a unique and unrepeatable product: material that is 'alive' and lives beyond time.





PLANK

COLLECTION

LAND



Rivestimento
in rovere
di palude
finitura
spazzolato
natura

Swamp white
oak panel
with Natural
brushed
finishing





Idoneo alla diretta esposizione
del sole e intemperie con
manutenzione periodica



EXTERIOR

OLD



Rivestimento
in rovere
di palude
finitura
spazzolato
grigio sabbia

Swamp
white oak
panel with
Grey Sand
brushed
finishing



FLOOR



Rivestimento
in rovere di
palude finitura
spazzolato natura
e inserto in
acciaio inox

Swamp white
oak panel with
Natural brushed
finishing and
stainless steel
insert



MASSELLI

COLLECTION

STRADIVARI



Rivestimento
in legno
massello
Iroko.

Iroko solid
wood panel



ARCADIA



Rivestimento
in legno
massello
Iroko.

Iroko solid
wood panel



BURIAN



Rivestimento
in legno
massello
Rovere noce
scuro.

Dark brown
Oak solid
wood panel



MINSTRAL



Rivestimento
in legno
massello
Tulipier noce
medio.

Medium
brown
Tulipier solid
wood panel





Idoneo alla diretta esposizione
del sole e intemperie con
manutenzione periodica



EXTERIOR

DERUTA



Rivestimento
in legno
massello
Castagno
scuro.

Dark
Chestnut
solid wood
panel



RINASCENTE



Rivestimento
in legno
massello
Castagno
scuro.

Dark
Chestnut
solid wood
panel



NAVIGLIO



Rivestimento
in legno
massello
Rovere
Miele.

Honey Oak
solid wood
panel



RIALTO



Rivestimento
in legno
massello
Olmo noce
medio.

Medium
brown Elm
solid wood
panel



MASSELLI

COLLECTION

R4 DUE ANTE SIMMETRICHE



Rivestimento
in legno
massello
Douglas.

Douglas solid
wood panel



R4 DUE ANTE ASIMMETRICHE



Rivestimento
in legno
massello
Pino
naturale.

Natural pine
solid wood
panel



R4



Rivestimento
in legno
massello
Iroko.

Iroko solid
wood panel





Idoneo alla diretta esposizione
del sole e intemperie con
manutenzione periodica



EXTERIOR

C7

**R6 DUE ANTE
ASIMMETRICHE**

R6



Rivestimento
in legno
massello
Castagno.

Chestnut
solid wood
panel



Rivestimento
in legno
massello
Castagno.

Chestnut
solid wood
panel



Rivestimento
in legno
massello
Pino
naturale.

Natural Pine
solid wood
panel



MASSELLI

COLLECTION



FORTUNA DUE ANTE



Rivestimento
in legno
massello
Castagno.

Chestnut
solid wood
panel



FORTUNA



Rivestimento
in legno
massello
Iroko.

Iroko solid
wood panel





Idoneo alla diretta esposizione
del sole e intemperie con
manutenzione periodica



EXTERIOR

FCH



Rivestimento
in legno
massello
Castagno.

Chestnut
solid wood
panel



FV



Rivestimento
in legno
massello e
compensato
marino
Rovere.

Water oak
wood and
plywood
panel





PANTOGRAFATI

interpretazioni in stile classico e moderno

COLLECTION
EXTERIOR



Rivestimenti realizzati in multistrato marino di Okoumè o in MDF idrofugo, sono proposti in un ampio catalogo di modelli e colori. Per la loro versatilità estetica, segnano il sottile confine fra classicità e modernità, per dialogare indifferentemente sia con l'architettura contemporanea sia con quella di tradizione.

Made of multi-layer marine type Okoumè or water-repellent MDF (Medium Density Fibre), pantographed panels mark the fine line between classical and modern: ideal condition for an aesthetic choice that spontaneously communicates with contemporary architecture and tradition.



PANTOGRAFATI

COLLECTION



GOLD

Particolare versione GOLD.

Detail of the GOLD version.

PR4



Rivestimento Serie Gold Okoume tinto Noce.

Walnut painted Series Gold Okoume panel



PR4 DUE ANTE ASIMMETRICHE



Rivestimento Serie Standard Okoume tinto Rovere.

Oak painted Series Standard Okoume panel





Idoneo alla diretta esposizione
del sole e intemperie con
manutenzione periodica



EXTERIOR

PR3 DUE ANTE SIMMETRICHE



Rivestimento
Serie
Standard
Okoume
tinto Ciliegio.

Cherry
painted
Series
Standard
Okoume
panel



PR3 DUE ANTE ASIMMETRICHE



Rivestimento
Serie
Standarad
RAL 9010.

Series
Standard RAL
9010 panel



PR3



Rivestimento
Serie Gold
Okoume
tinto Rovere.

Oak painted
Series Gold
Okoume
panel



PANTOGRAFATI

COLLECTION

PRS



Rivestimento
Serie
Standard RAL
1015.

Series Gold
RAL 1015
panel



PRS DUE ANTE SIMMETRICHE



Rivestimento
Serie Gold
Okoume
tinto Noce
medio.

Walnut
painted
Series Gold
Okoume
panel



STANDARD

Particolare
versione
STANDARD

Detail of the
STANDARD
version



Idoneo alla diretta esposizione
del sole e intemperie con
manutenzione periodica



EXTERIOR

PRA3



Rivestimento
Serie Gold
RAL 9010.

Series Gold
RAL 9010
panel



PA5



Rivestimento
Serie Gold
Okoume
tinto Rovere.

Oak painted
Series Gold
Okoume
panel



PAR



Rivestimento
Serie
Standard
Okoume
tinto Rovere.

Oak painted
Series
Standard
Okoume
panel



PANTOGRAFATI

COLLECTION

PR2 DUE ANTE SIMMETRICHE



Rivestimento
Serie
Standard
Okoume
tinto Noce

Walnut
painted
Series
Standard
Okoume
panel



PR2 DUE ANTE ASIMMETRICHE



Rivestimento
Serie
Standard
Okoume
tinto Noce

Walnut
painted
Series
Standard
Okoume
panel



PR2



Rivestimento
Serie Gold
RAL 6005.

Series Gold
RAL 6005
panel





Idoneo alla diretta esposizione
del sole e intemperie con
manutenzione periodica



EXTERIOR

PAV1



Rivestimento
Sere Gold
RAL 9010.

Series Gold
RAL 9010
panel



PR6



Rivestimento
Serie Gold
RAL 1015.

Series Gold
RAL 1015
panel



PANTOGRAFATI

COLLECTION

MOD. A



Rivestimento
Okoume
tinto Ciliegio.

Cherry
painted
Okoume
panel



MOD. B



Rivestimento
RAL 9010.

RAL 9010
panel





Idoneo alla diretta esposizione del sole e intemperie con manutenzione periodica



EXTERIOR

MOD. H



Rivestimento Okoume tinto Rovere.

Oak painted Okoume panel



RIGO



Rivestimento Rovere tinto Wengè con inserti inox.

Oak wenge finish panel with stainless steel inserts



AP3



Rivestimento Serie Gold RAL 6005.

Series Gold RAL 6005 panel



AP6



Rivestimento Standard Okoume tinto Noce medio.

Walnut painted Series Standard Okoume panel



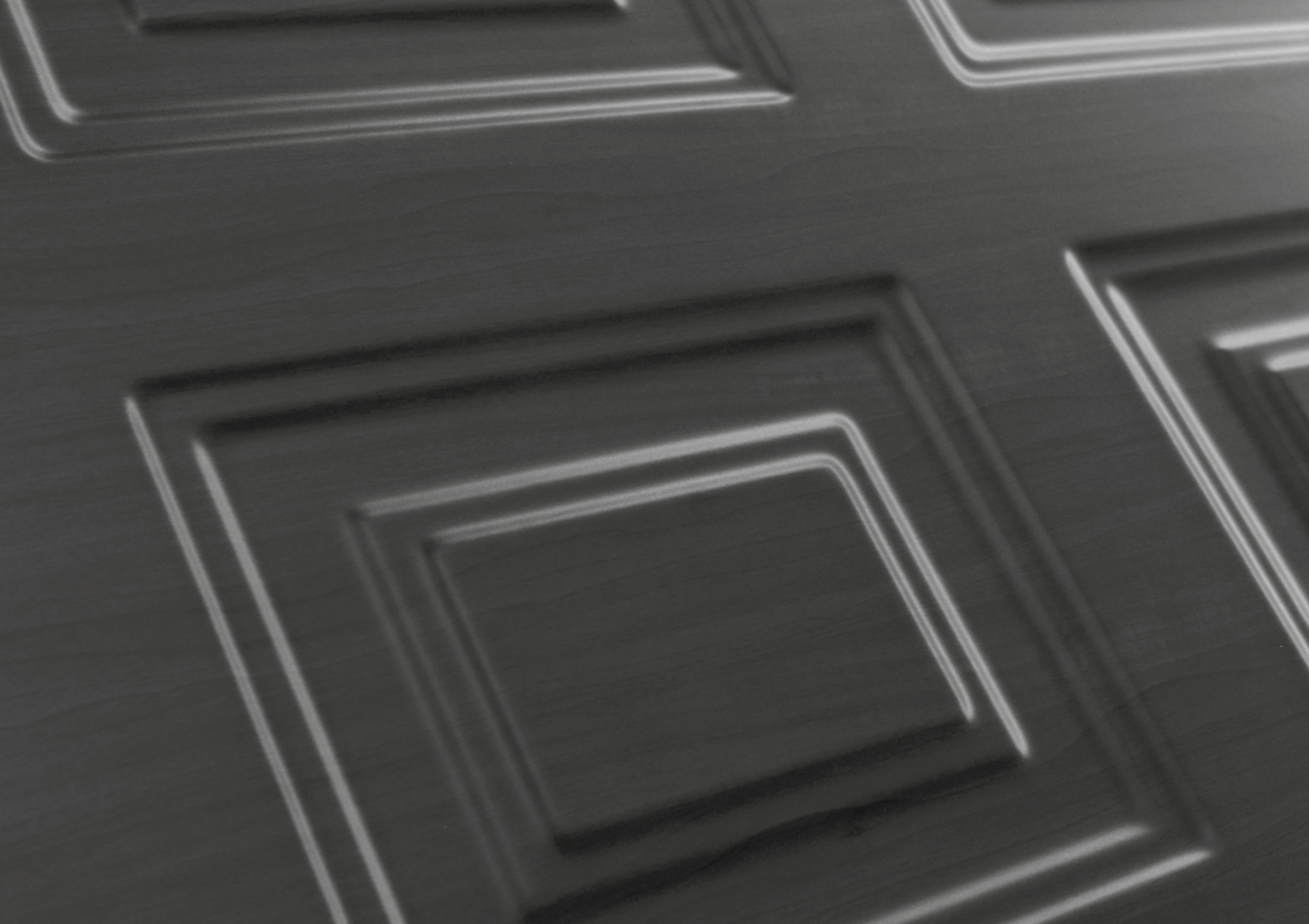

ALLUMINIO

interpretazioni in stile classico e moderno

COLLECTION EXTERIOR

Rivestimenti dalla spiccata impronta classica, la **Collezione Alluminio** unisce alle molteplici varianti di disegno e colori, eccellenti requisiti tecnici di isolamento termico e idrorepellenza. Queste proprietà, oltre a quella di speciali verniciature ad alte temperature, ne fanno un pannello solido, stabile, che non richiede manutenzione.

Panels with a strong classical imprint, the **Aluminium Collection** combines various design and colours with excellent technical requirements of thermal insulator and water repellent. These properties, in addition to that of special high temperature paint work, make it a solid, stable pane, which does not require any maintenance.





ALLUMINIO

COLLECTION

TORAL



Rivestimento
in alluminio
laccato
bianco
Fiamma
e Nodi e
inserto inox
Fiamma and
Nodi white
lacquered
aluminium
panel and
stainless
steel insert





Idoneo alla diretta esposizione del sole e intemperie



EXTERIOR

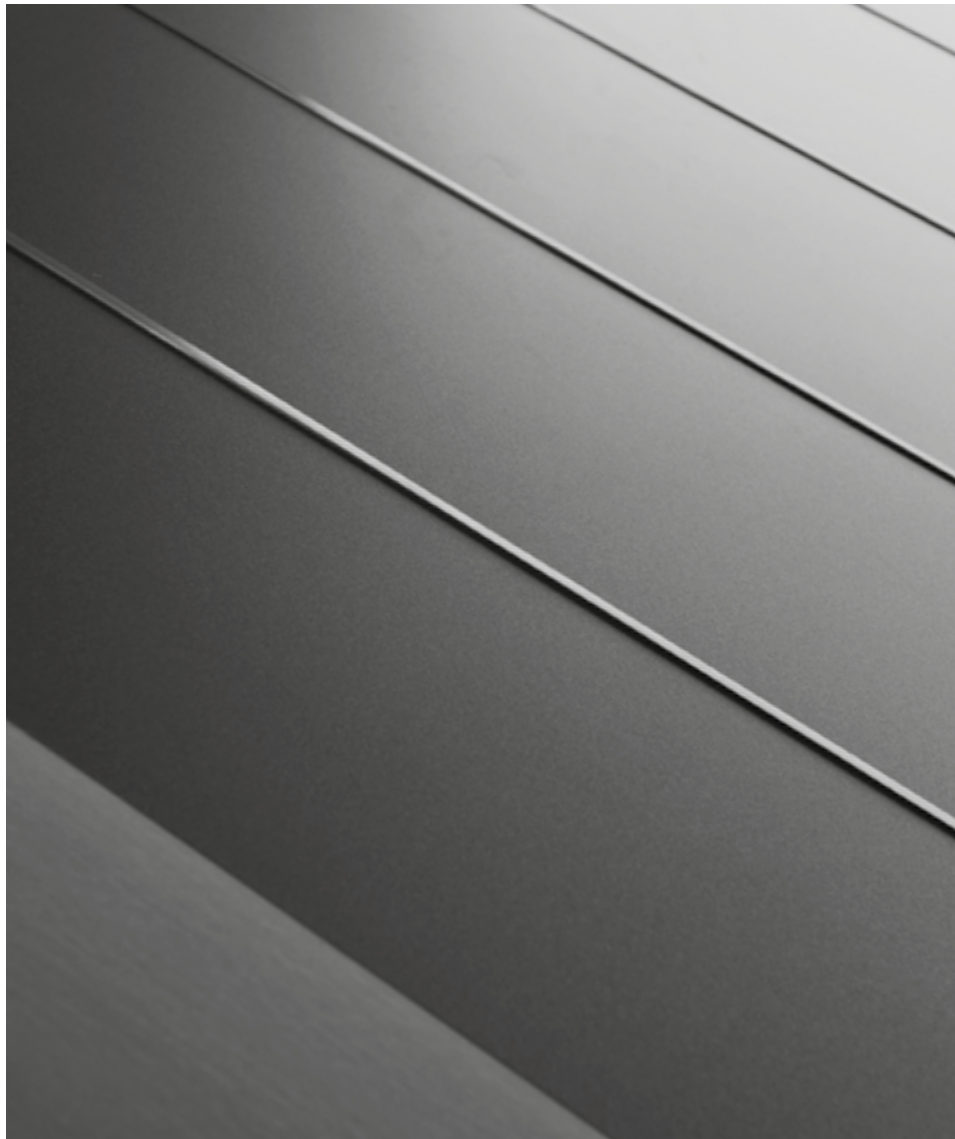

RIGAL



Rivestimento in alluminio RAL 1013 con inserti inox

Aluminium RAL 1013 panel with stainless steel inserts



UNOAL



Rivestimento in alluminio RAL 7030 con inserto inox

Aluminium RAL 7030 panel with stainless steel insert



ALLUMINIO

COLLECTION

BELATRIX



Rivestimento
in Alluminio
RAL 6005.

RAL 6005
Aluminium
panel



BELATRIX DUE ANTE ASIMMETRICHE



Rivestimento
in Alluminio
Renolit
Ciliegio.

Cherry
Renolit
Aluminium
panel



ERIDANO K



Rivestimento
in Alluminio
RAL 1013.

RAL 1013
Aluminium
panel





Idoneo alla diretta esposizione del sole e intemperie



EXTERIOR

ERIDANO K DUE ANTE ASIMMETRICHE



Rivestimento in Alluminio verniciato effetto Legno Noce.

Walnut wood varnished effect aluminium panel



AURIGA DUE ANTE ASIMMETRICHE



Rivestimento in Alluminio Verde Raffaello.

Raffaello Green Aluminium panel



AURIGA



Rivestimento in Alluminio RAL 7040.

RAL 7040 Aluminium panel



ALLUMINIO

COLLECTION

MIRANDA K



Rivestimento
in Alluminio
RAL 6005.

RAL 6005
Aluminium
panel



MIRANDA K DUE ANTE ASIMMETRICHE



Rivestimento
in Alluminio
RAL 1013.

RAL 1013
Aluminium
panel



ABACO K



Rivestimento
in Alluminio
verniciato
effetto
Douglas.

Douglas
wood
varnished
effect
aluminium
panel





Idoneo alla diretta
esposizione del sole
e intemperie



EXTERIOR

ABACO K DUE ANTE ASIMMETRICHE



Rivestimento
in Alluminio
RAL 9010.

RAL 9010
Aluminium
panel



REGOLO KA



Rivestimento
in Alluminio
RAL 9010.

RAL 9010
Aluminium
panel







PVC

resistenti duraturi e privi di manutenzione

COLLECTION EXTERIOR

Scelta economicamente vantaggiosa, ma non per questo banale, le porte blindate con rivestimento in PVC sono solide, idrorepellenti.

Proposte in un'ampia gamma di stili, colori e finiture, possono essere in versione 'cieca' o a vetro, e non richiedono alcuna manutenzione.

Cost-effective choice, but by no means trivial, armoured doors with PVC panels are solid, water-resistant. Offered in a wide range of styles, colours and finishes, they can be 'blind' or glass doors, and require no maintenance.





PVC

COLLECTION

MOD. 002



Rivestimento
in PVC colore
Quercia
Mocca 048.

PVC panel
Oak Mocca
048 colour





MOD. 006



Rivestimento
in PVC colore
Quercia
Kolonial 036.

PVC panel
Oak Kolonial
036 colour



MOD. 012



Rivestimento
in PVC colore
Quercia
Kolonial 036.

PVC panel
Oak Kolonial
036 colour



MOD. 014



Rivestimento
in PVC colore
Quercia Terra
035.

PVC panel
Oak Terra
035 colour



PVC

COLLECTION

MOD. 029



Rivestimento
in PVC
colore Noce
Kolonial 062.

PVC panel
Walnut
Kolonial 062
colour



MOD. 092



Rivestimento
in PVC
colore Noce
Sorrento
042.

PVC panel
Walnut
Sorrento 042
colour





Idoneo alla diretta esposizione del sole e intemperie



EXTERIOR

MOD. 093



Rivestimento in PVC colore Beige 015.

PVC panel Beige 015 colour



MOD. 033



Rivestimento in PVC colore Sheffield Oak 081.

PVC panel Sheffield Oak 081 colour



MOD. 036



Rivestimento in PVC colore Platino 004.

PVC panel Platino 004 colour



MOD. 076



Rivestimento in PVC colore Quercia Tabacco 007.

PVC panel Oak Tabacco 007 colour



PVC

COLLECTION



MOD. 051



Rivestimento
in PVC colore
Quercia
Kolonial 036.

PVC panel
Oak Kolonial
036 colour



MOD. 057



Rivestimento
in PVC colore
Betulla 031.

PVC panel
Birch 031
colour





Idoneo alla diretta
esposizione del sole
e intemperie



EXTERIOR

MOD. 066



Rivestimento
in PVC colore
Sheffield Oak
081.

PVC panel
Sheffield Oak
081 colour



MOD. 124



Rivestimento
in PVC colore
Quercia
Mocca 048.

PVC panel
Oak Mocca
048 colour



MOD. 125



Rivestimento
in PVC colore
Quercia
Mocca 048.

PVC panel
Oak Mocca
048 colour



PVC

COLLECTION



MOD. 201



Rivestimento
in PVC colore
Quercia
Mocca 048.

PVC panel
Oak Mocca
048 colour





Idoneo alla diretta esposizione del sole e intemperie



EXTERIOR

MOD. 191



Rivestimento in PVC colore Rosso Rubino.

PVC panel Rubini Red colour



MOD. 302



Rivestimento in PVC colore Metallic Wood Mocca 011.

PVC panel Metallic Wood Mocca 011 colour



MOD. 190



Rivestimento in PVC colore Marrone Nero Opaco.

PVC panel Matt BrownBlack colour









DESIGN

Tracce di forma e contrasti materici

COLLECTIONS INTERIOR

1. Linea
2. Metalli
3. Tratto

Caratterizzata da un'impronta formale contemporanea nello stile e nei materiali impiegati, la **Collezione Design** è proposta in tre versioni che abbinano superfici monocrome incise, superfici in legno con inserti di metallo, superfici in acciaio inox e corten.

Characterized by a formal contemporary imprint in the style and the materials used, the **Design Collection** is available in three versions that combine monochrome engraved surfaces, wood surfaces with metal inserts, stainless steel surfaces and corten.



LINEA DUE VERTICALE DUE ANTE ASIMMETRICHE



Rivestimento
in Rovere
sbiancato
con inserti in
alluminio.
Rivestimento
avvolgente
Bleached oak
panel with
aluminium
inserts

I

LINEA DUE VERTICALE



Rivestimento
laccato verde
tenue con
inserti in
alluminio.
Rivestimento
avvolgente.
Pale green
lacquered
panel with
aluminium
inserts

I

LINEA DUE ORIZZONTALE DUE ANTE ASIMMETRICHE



Rivestimento
laccato
tabacco con
inserti in
alluminio.
Rivestimento
avvolgente.
Tobacco
lacquered
panel with
aluminium
inserts

I



Idoneo
esclusivamente per
ambienti interni



INTERIOR

LINEA QUADRA



Rivestimento
laccato
crema con
inserti in
alluminio.
Rivestimento
avvolgente.
White cream
lacquered
panel with
aluminium
inserts



LINEA UNO ORIZZONTALE



Rivestimento
in frassino
bianco con
inserti in
alluminio.
Rivestimento
avvolgente.
White
ash wood
panel with
aluminium
insert



LINEA MULTIPLA



Rivestimento
in wengè
con inserti in
alluminio.
Rivestimento
avvolgente.

Wenge
panel with
aluminium
inserts





METALLI

COLLECTION

ORIONE



Rivestimento
laccato ecrù
e laminato
acciaio.
Rivestimento
avvolgente.

Ecrù
lacquered
panel
and steel
laminated





Idoneo
esclusivamente per
ambienti interni



INTERIOR

PEGASO



Rivestimento
in rovere
grigio e
laminato
acciaio.
Rivestimento
avvolgente.
Grey oak
panel
and steel
laminated



POLARIS



Rivestimento
in noce
nazionale
e laminato
acciaio.
Rivestimento
avvolgente.
Italian
Walnut panel
and steel
laminated



ANDROMEDA



Rivestimento
in zebrano
e laminato
acciaio.
Rivestimento
avvolgente.

Zebrano
panel
and steel
laminated



TRATTO

COLLECTION

PENELOPE



Rivestimento laccato verde con incisioni ribassate. Rivestimento avvolgente.

Pale Green lacquered panel with incisions



POLIFEMO



Rivestito laccato crema con incisioni ribassate. Rivestimento avvolgente. White cream lacquered panel with incisions



ULISSE



Rivestimento laccato tabacco con incisioni ribassate. Rivestimento avvolgente. Tobacco lacquered panel with incisions



MEDUSA



Rivestimento laccato caffè con incisioni ribassate. Rivestimento avvolgente.

Coffee lacquered panel with incisions





Idoneo
esclusivamente per
ambienti interni



INTERIOR

EURIDICE



Rivestimento
laccato
lavanda con
incisioni
ribassate.
Rivestimento
avvolgente.
Lavender
lacquered
panel with
incisions



TRATTO

COLLECTION



ATENA



Rivestimento laccato crema con incisioni ribassate. Rivestimento avvolgente. White cream lacquered panel with incisions



ARTEMIDE



Rivestimento laccato ecru con incisioni ribassate. Rivestimento avvolgente. Ecru lacquered panel with incisions





Idoneo
esclusivamente per
ambienti interni



INTERIOR

DIONISO



Rivestimento
laccato caffè
con incisioni
ribassate.
Rivestimento
avvolgente.

Coffee
lacquered
panel with
incisions



DEMETRA



Rivestimento
laccato verde
tenue con
incisioni
ribassate.
Rivestimento
avvolgente.

Pale Green
lacquered
panel with
incisions



VENERE



Rivestimento
laccato RAL
9010 con
incisioni
ribassate.
Rivestimento
avvolgente.
RAL 9010
lacquered
panel with
incisions





ELITE

ricerca estetica di prestigio

COLLECTIONS INTERIOR

1. Intarsi
2. Preziosi
3. Rilievo
4. Riflessi

Con quattro linee di alta gamma, nella **Collezione Elite**, Effepi® indirizza la sua ricerca estetica sui rivestimenti, verso soluzioni di autentico prestigio. Realizzate con materiali, inserti e lavorazioni di eccellenza, ogni superficie si distingue per sofisticata eleganza e forte personalità.

With four high-end lines, the Effepi® **Elite collection** focuses its aesthetic research on the panels, towards authentic prestige solutions. Made of materials, inserts and excellent manufacturing, every surface is distinguished by sophisticated elegance and strong personality.





INTARSI

COLLECTION

VERDI



Rivestimento
in rovere
sbiancato.
Rivestimento
avvolgente.

Bleached oak
panel





Idoneo
esclusivamente per
ambienti interni



INTERIOR

ROSSINI



Rivestimento
in noce
nazionale.
Rivestimento
avvolgente.

Italian
Walnut panel



PUCCINI



Rivestimento
in noce
nazionale.
Rivestimento
avvolgente.

Italian
Walnut panel



SHUBERT



Rivestimento
in wengè.
Rivestimento
avvolgente.

Wenge panel



BACH



Rivestimento
in rovere
sbiancato.
Rivestimento
avvolgente.

Bleached oak
panel



PREZIOSI

COLLECTION

ISCHIA



Rivestimento in rovere grigio con inserti in cristalli taglio diamante. Rivestimento avvolgente.

Grey oak panel with glass inserts



ISCHIA DUE ANTE ASIMMETRICHE



Rivestimento in frassino bianco con inserti in cristalli taglio diamante. Rivestimento avvolgente.

White ash wood panel with glass inserts





Idoneo
esclusivamente per
ambienti interni



INTERIOR

PANAREA



Rivestimento
in wengè
con inserti in
cristalli taglio
diamante.
Rivestimento
avvolgente.

Wenge panel
with glass
inserts



PANAREA



Rivestimento
laccato
lavanda con
inserti in
cristalli taglio
diamante.
Rivestimento
avvolgente.

Lavender
lacquered
panel with
glass inserts



CAPRI



Rivestimento
in rovere
sbiancato
con inserti in
cristalli taglio
diamante.
Rivestimento
avvolgente.

Bleached oak
panel with
glass insert





RILIEVO

COLLECTION

KALI



Rivestimento
in wengè.
Rivestimento
avvolgente.

Wenge panel





Idoneo
esclusivamente per
ambienti interni



INTERIOR

AVATAR



Rivestimento
in rovere
sbiancato.
Rivestimento
avvolgente.

Bleached oak
panel



SHIVA



Rivestimento
in rovere
grigio.
Rivestimento
avvolgente.

Grey oak
panel



RIFLESSI

COLLECTION





Idoneo
esclusivamente per
ambienti interni



INTERIOR

SIRIO



Rivestimento
in frassino
tabacco.
Rivestimento
avvolgente.

Tobacco ash
wood panel
with shiny
lacquered
side



VEGA



Rivestimento
in frassino
bianco.
Rivestimento
avvolgente.

White ash
wood panel
with shiny
lacquered
side



WALL

soluzioni di continuità esclusive

COLLECTIONS INTERIOR

1. Terre
2. Paper

La collezione propone finiture materiche in speciali terre e malte trattate manualmente o carta da parati.

Questi rivestimenti consentono di ottenere superfici complanari e di continuità che integrano il rivestimento interno della porta con la parete circostante, per una scelta architettonica esclusiva e innovativa.

Composed of the line *Earth and Wallpaper*. This collection obtains planar and seamless surfaces integrating the inside panel of the door with that of the surrounding wall, for an exclusive and innovative architectural choice.



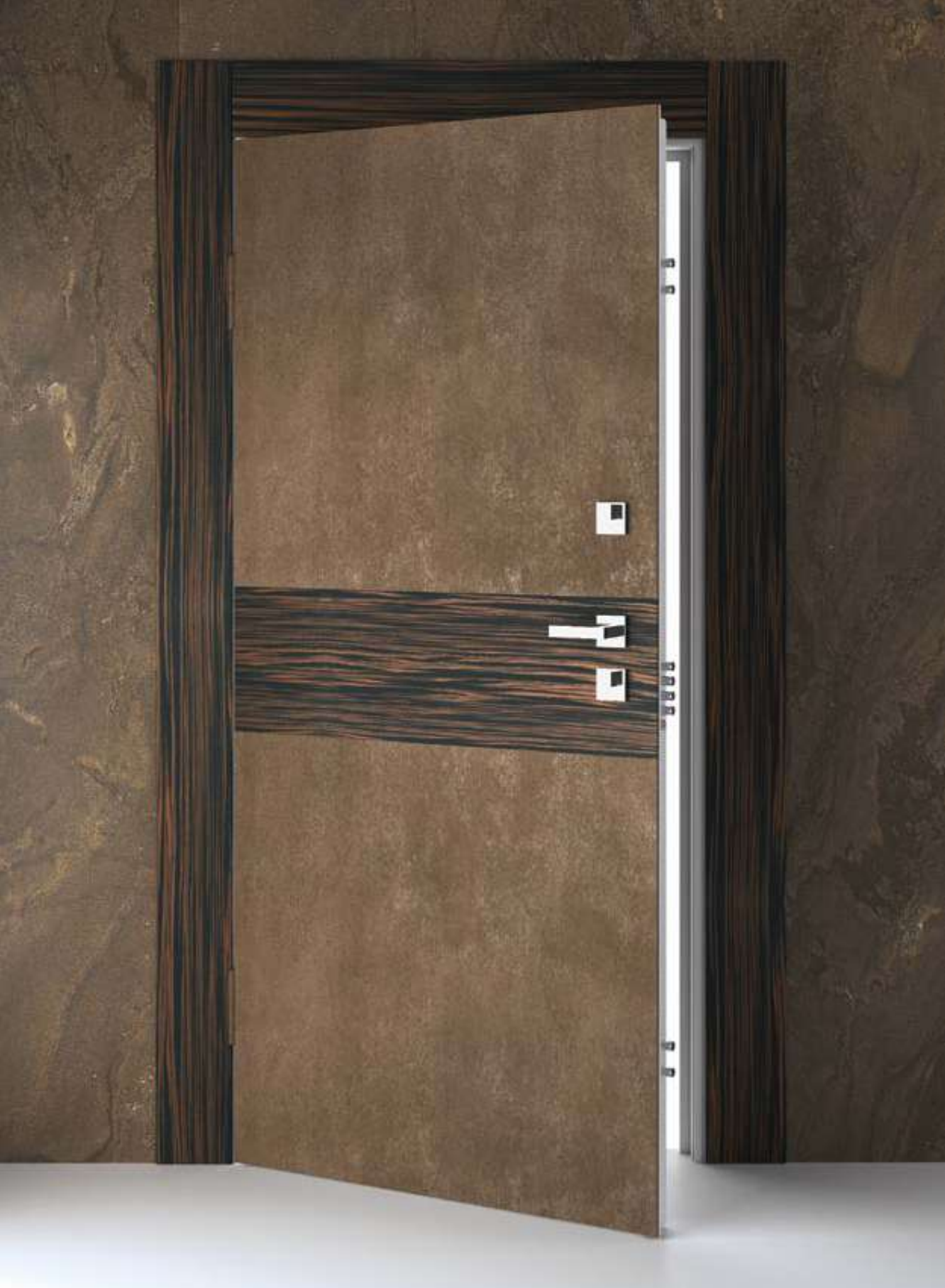

TERRE

COLLECTION

BIANCURA



Rivestimento in
Cemento Bosco e
inserto Ebano

Woods
Cement
panel and
ebony insert





Idoneo
esclusivamente per
ambienti interni



INTERIOR

BONACCIA



Rivestimento in
Cemento Grigio
Tempesta e
inserto in Noce
Canaletto

Grey Storm
Cement
panel and
Canaletto
walnut
insert



CALMA



Rivestimento in
Cemento Grigio
Acciaio

Steel Grey
Cement
panel



PAPER

COLLECTION

CONCRETE



Texture
stile urban,
effetto
cemento

Textures
urban style,
concrete
effect



TORINO



Eleganza
senza
tempo fatta
di tessuti
pregiati,
decori floreali

A timeless
elegance
made of
fine fabrics,
geometry
and floral
decorations



E2R2



Pattern
e texture
alternano
uno stile
urban chic
che unisce
il cemento
al decoro
floreale

Patterns and
textures are
alternated
an urban chic
style that
combines
concrete
and floral
decorations





Idoneo
esclusivamente per
ambienti interni



INTERIOR

PRUNUS



Texture
stile urban,
effetto
cemento

Textures
urban style,
concrete
effect



Courtesy of INKIOSTRO BIANCO





Courtesy of INKIOSTRO BIANCO

PAPER

COLLECTION

DIANTHUS 1



I decori si sovrappongono nella definizione di una calda suggestione esotica

The decorations superimposed to define a warm and exotic splendour





Idoneo
esclusivamente per
ambienti interni



INTERIOR

DIANTHUS 2



I decori si
sovrappongono
nella
definizione
di una calda
suggerione
esotica

The decorations
superimposed
to define a
warm and exotic
splendour





PIANA

La semplicità è la massima raffinatezza

COLLECTION

1. Orizzontale
2. Verticale

Rivestimenti semplici ma ben strutturati, presentano superfici lisce con venatura legno orizzontale o verticale in gran parte già disponibili a magazzino.

Simple but well structured panels, which have smooth surfaces with horizontal or vertical wood grain most already in stock



Orizzontale

COLLECTION

SERIE PIANA ORIZZONTALE



Rivestimento
in zebrano.
Rivestimento
avvolgente.

Zebrano
wood panel

I



Idoneo
esclusivamente per
ambienti interni



INTERIOR

SERIE PIANA ORIZZONTALE



Rivestimento
in frassino
nero.
Rivestimento
avvolgente.

Black ash
wood panel



SERIA PIANA ORIZZONTALE DUE ANTE ASIMMETRICHE



Rivestimento
in frassino
bianco.
Rivestimento
avvolgente.

White ash
wood panel

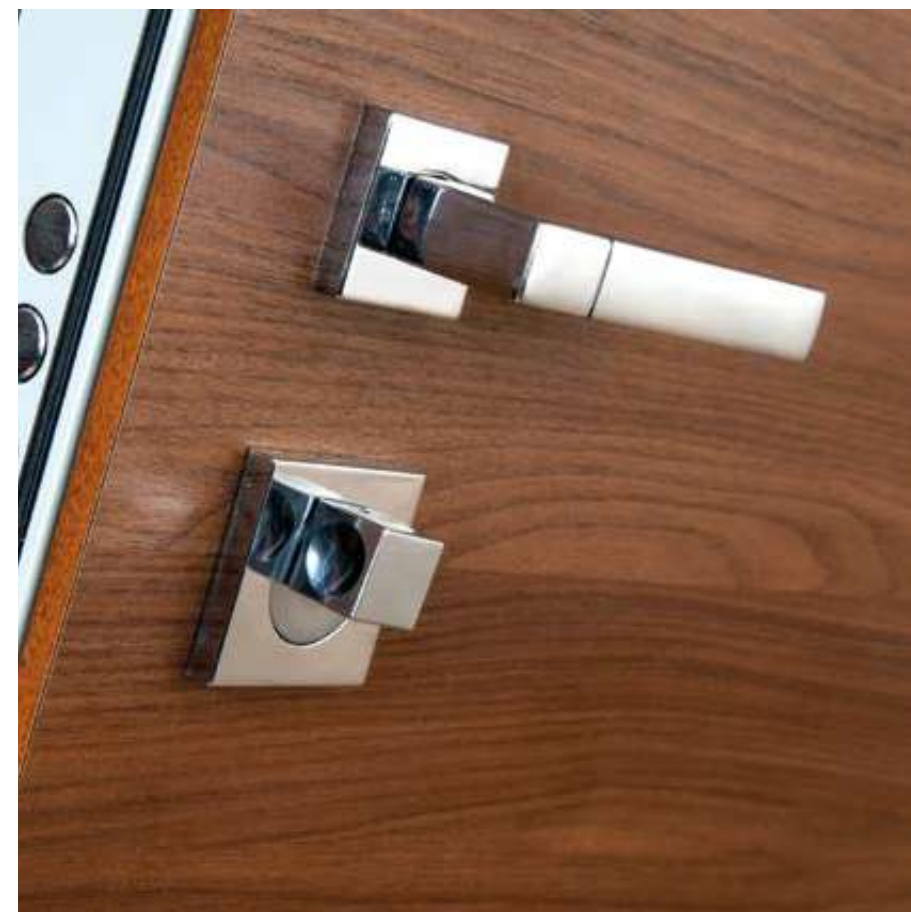



Verticale

COLLECTION

SERIE PIANA VERTICALE



Rivestimento
in ciliegio.
Rivestimento
avvolgente.

Cherry wood
panel





Idoneo
esclusivamente per
ambienti interni



INTERIOR

SERIE PIANA VERTICALE



Rivestimento
in rovere.
Rivestimento
avvolgente.

Oak wood
panel



SERIE PIANA VERTICALE



Rivestimento
in tanganyika.
Rivestimento
mm. 7

Tanganika
walnut panel
mm. 7 thick
panel







TRASPARENZE

Sopraluce, finestrature, latoluce

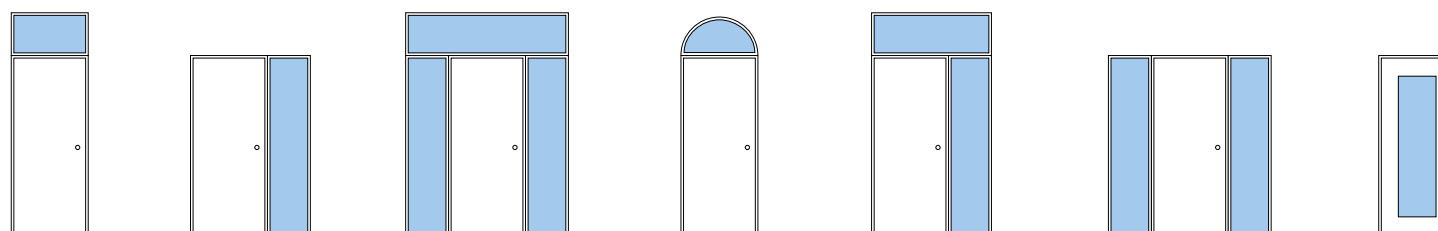

La tecnica costruttiva EFFEPI® consente di realizzare e personalizzare ampie finestre nelle ante, con l'inserimento di vetri blindati stratificati vengono mantenute inalterate le caratteristiche di affidabilità e di sicurezza, creando un piacevole effetto estetico.

Inoltre, a seconda delle esigenze, alle porte blindate EFFEPI® possono essere abbinati latoluce singoli o doppi e/o sopraluce. Latoluce e sopraluce sono costruiti con lo stesso profilato del telaio porta (garanzia di robustezza) ed assemblabili in cantiere con grande vantaggio per i trasporti.

Le modanature interne ed esterne, in legno o in altri materiali, a copertura dei montanti e del traverso completano e rendono gradevole l'intera struttura.

Tutti i vetri blindati utilizzati da EFFEPI® sono stratificati, accoppiati sempre con vetrocamera a bassa trasmittanza termica e possono essere forniti in vari colori e finiture.

The EFFEPI® construction technique allows realizing and customizing large windows in the doors, with the insertion of laminated armoured glass the reliability and safety characteristics are maintained unchanged, creating a pleasant aesthetic effect.

Furthermore, depending on the needs, the EFFEPI® armoured doors can be matched with single or double light sides and/or fanlight.

Light side and fanlight are built with the same section of the door frame (guaranteeing sturdiness) and assembled on site with great advantage for transport.

The interior and exterior mouldings, made of wood or other materials, covering the pillars and the crossbeam complete and make pleasant the whole structure.

All armoured glass used by EFFEPI® are layered, always coupled with a low thermal transmittance double glass unit and can be supplied in various colours and finishes.



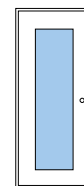

FINISTRATURE WINDOWS

Le finestratura realizzata sulle ante garantisce la blindatura della porta creando il passaggio della luce.

The windows on the leaves guarantee armoring of the door while creating a passage of light.

TRASPARENZE

Sopraluce, finestre, latoluce



SOPRALUCE E SOPRALUCE AD ARCO TRANSOM WINDOW AND ARCHED TRANSOM WINDOW

Il sopraluce estende la sicurezza della porta creando un passaggio di luce attraverso vetrate blindate.

The transom window extends the safety of the door creating a passage of light through the armoured glass.

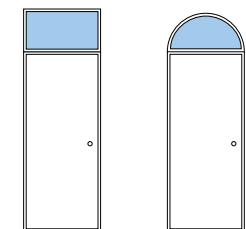

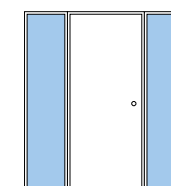

**LATOLUCE DX E/O SX
RIGHT AND /OR LEFT
SIDE LIGHT**

Il latoluce DX e/o SX o in entrambi i lati, consente passaggi di luce realizzando soluzioni blindate di notevole effetto.

The right and/or left side light - or both sides - allow the passage of light realising armoured solutions with considerable effect.

TRASPARENZE

Sopraluce, finestre, latoluce

SOPRALUCE E LATOLUCE TRANSOM WINDOW AND SIDE LIGHT

La combinazione tra sopraluce e latoluce unisce la sicurezza a soluzioni architettoniche importanti.

The combination of transom window and side light unites safety to significant architectonic solutions.

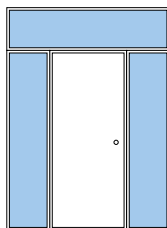



TRASPARENTE
TRANSPARENT



SATINATO
SATIN



GRIGIO
GREY



VERDE
GREEN



AZZURRO
BLUE



BRONZO
BRONZE



TRASPARENZE

colori, satinati e dettagli tecnici

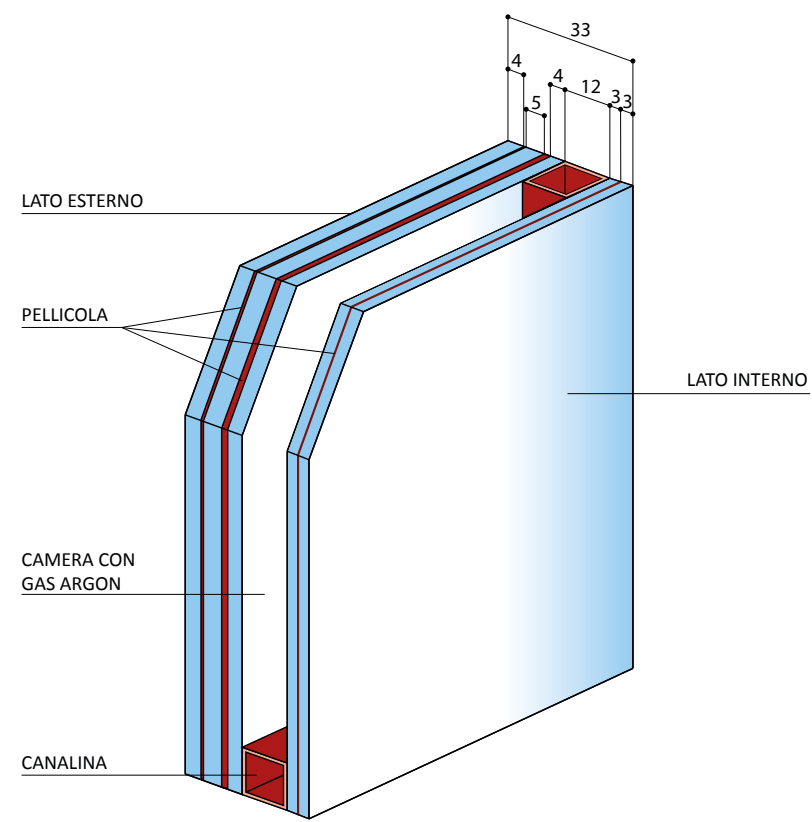



LE MANIGLIE



MANIGLIA

ROBOQUATTRO

I modelli **ROBOQUATTRO** ed **ELLESE** sono di serie a scelta su tutti i modelli di porta.

The models **ROBOQUATTRO** and **ELLESE** are standard to be chosen on all door models.



FINITURE:



OROPLUS



CROMAT



CROMO



MANIGLIA ELLESSE

I modelli **ROBOQUATTRO** ed **ELLESSE** sono di serie a scelta su tutti i modelli di porta.

The models **ROBOQUATTRO** and **ELLESSE** are standard to be chosen on all door models.

FINITURE:



CROMAT



CROMO



MANIGLIA UNIVERSAL



FINITURE:

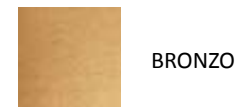

BRONZO



OTTONE
LUCIDO



CROMO
SATINATO



CROMO
LUCIDO



OLIVARI

MANIGLIA SECTOR



FINITURE:



MIX CROMO
SATINATO/LUCIDO



MIX SUPERORO
SATINATO/LUCIDO



OLIVARI

MANIGLIA PLANET Q



FINITURE:



MIX CROMO
SATINATO/LUCIDO



MIX SUPERORO
SATINATO/LUCIDO



OLIVARI

MANIGLIA TECNO

FINITURE:



MIX CROMO
SATINATO/LUCIDO



MIX SUPERORO
SATINATO/LUCIDO



MANIGLIA FRAME

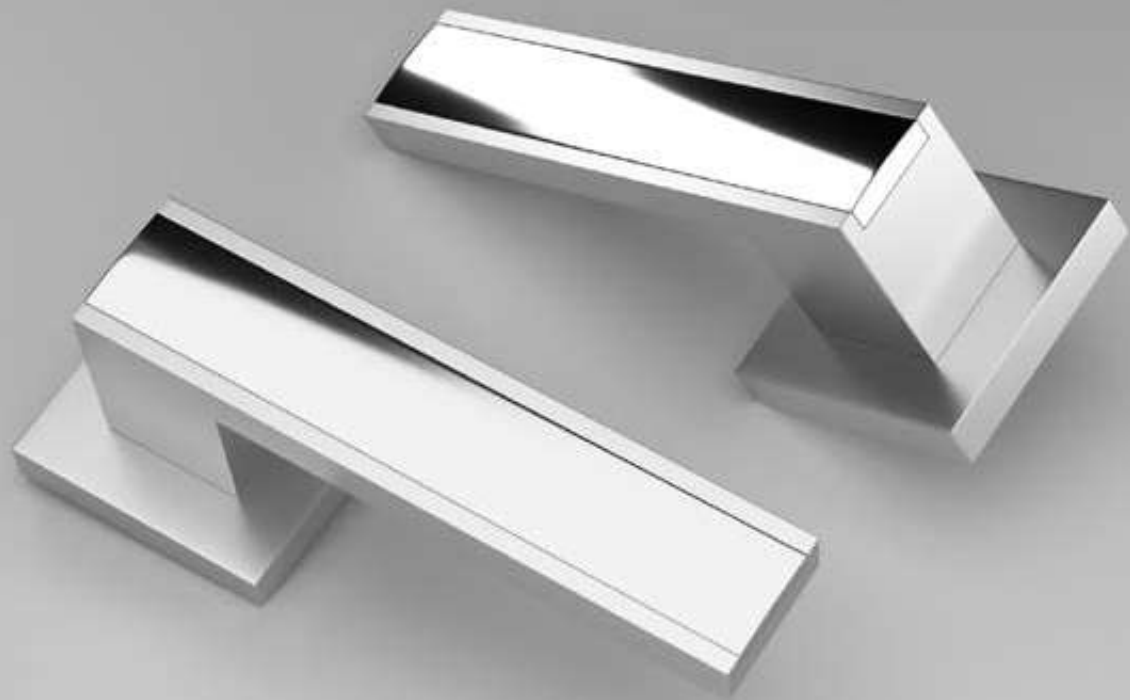

FINITURA:



MIX CROMO
SATINATO/LUCIDO





MANIGLIONE FRAME

FINITURA:



MIX CROMO
SATINATO/LUCIDO

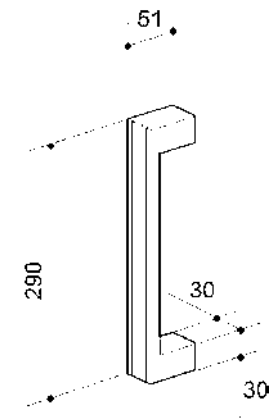

MANIGLIONE NICE

FINITURE:



OROPLUS



CROMAT



CROMO

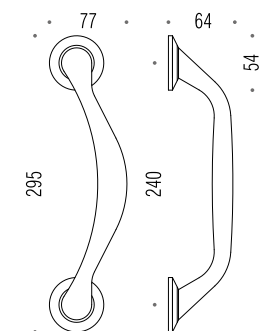

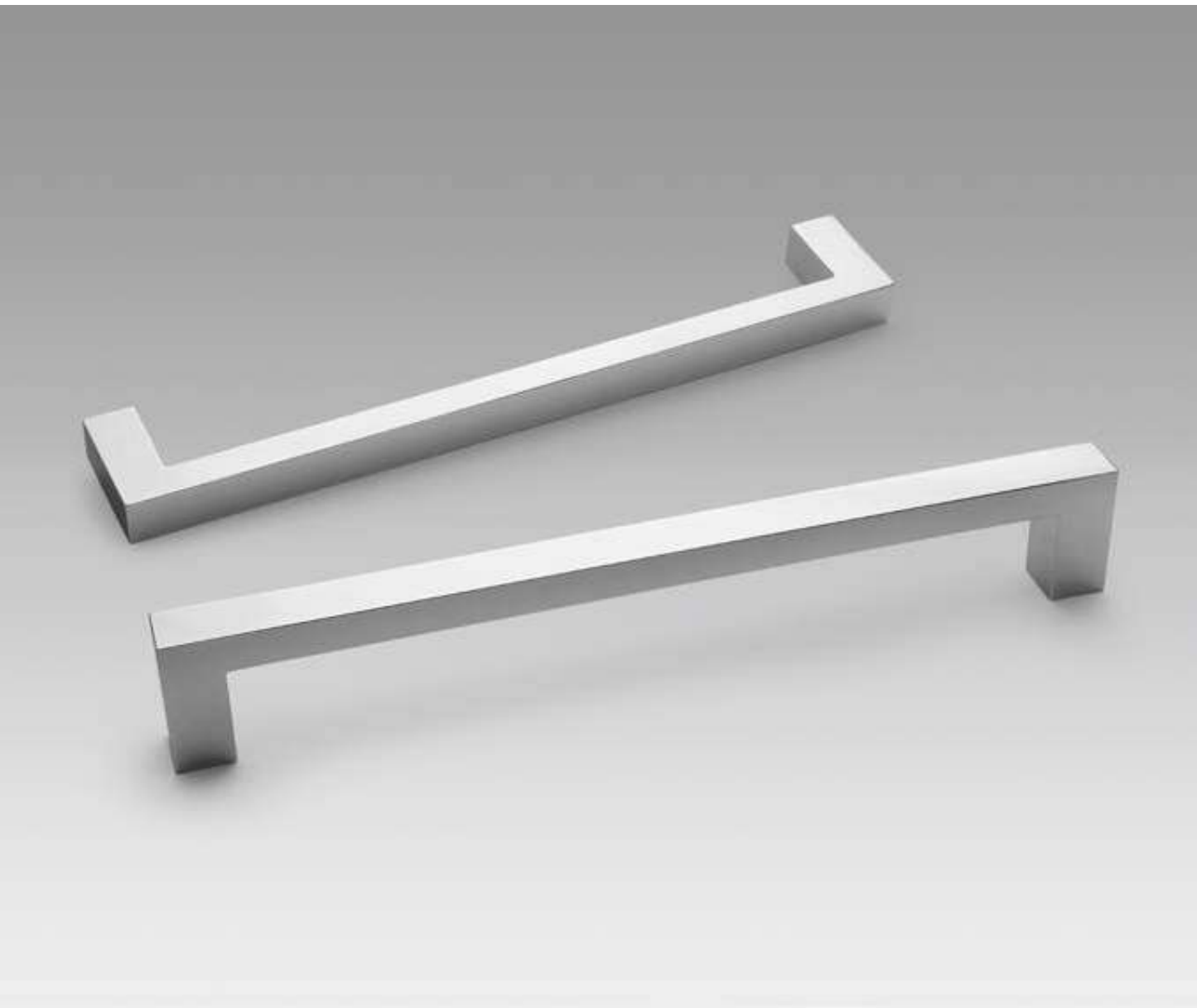

MANIGLIONE

QUADRO

Maniglione dalla forma essenziale in acciaio inox AISI 316L, il più resistente ed elastico tra gli acciai. Realizzato nella finitura satinata.

Essentially-shaped push-bar in AISI 316L stainless steel, the hardest, most resistant and elastic of all types of steel. Made of satin finish.

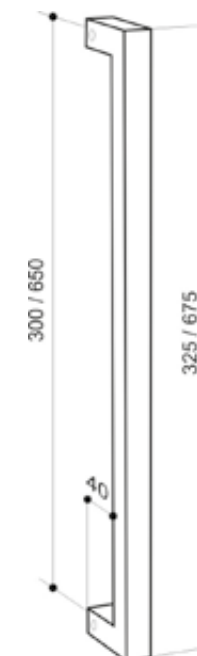

FINITURA:



ACCIAIO
SATINATO

MANIGLIONE

NOA

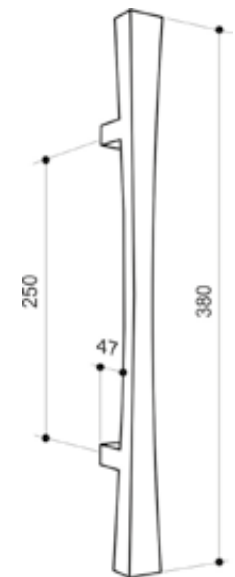
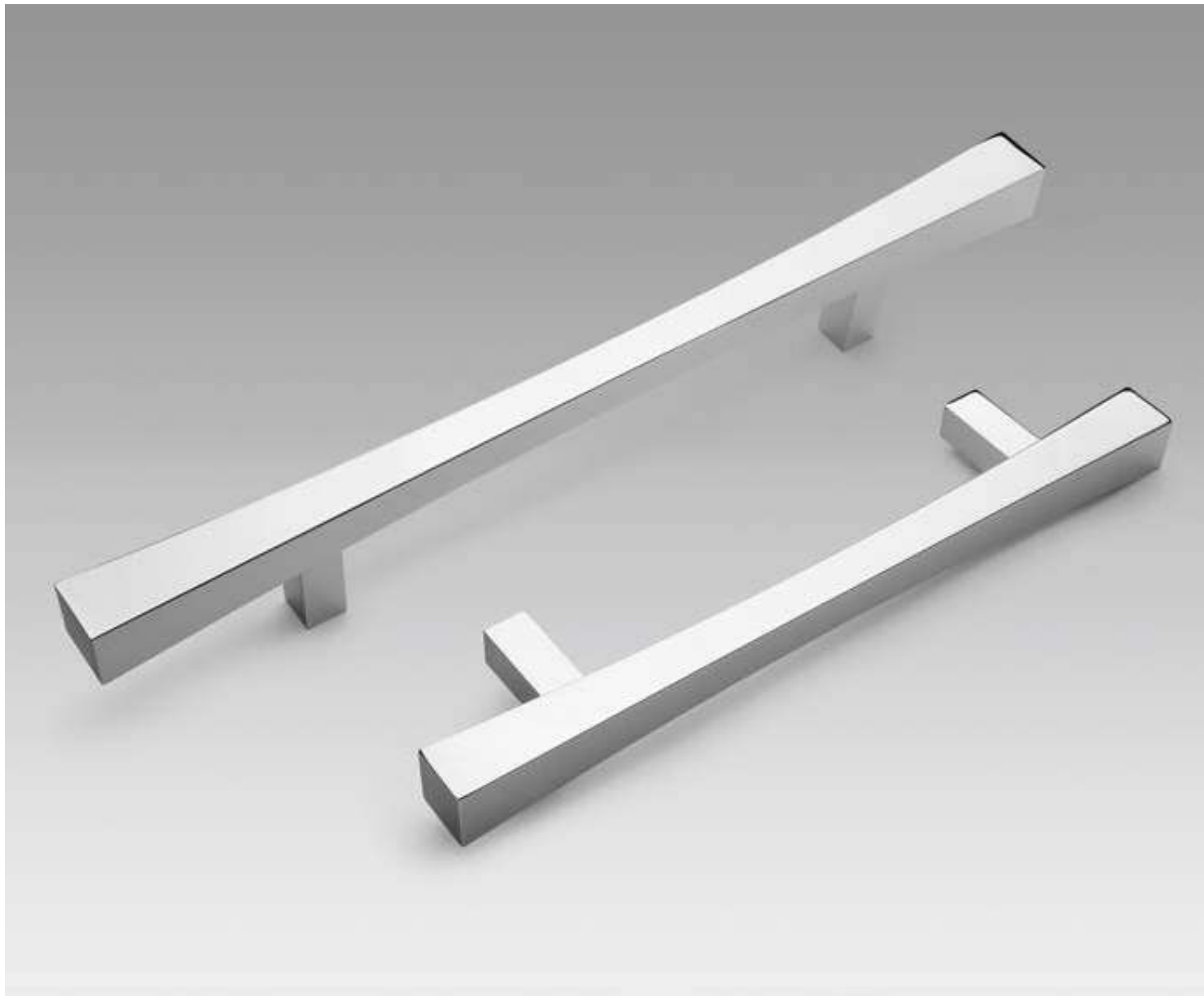

FINITURE:



OROPLUS



CROMAT



CROMO

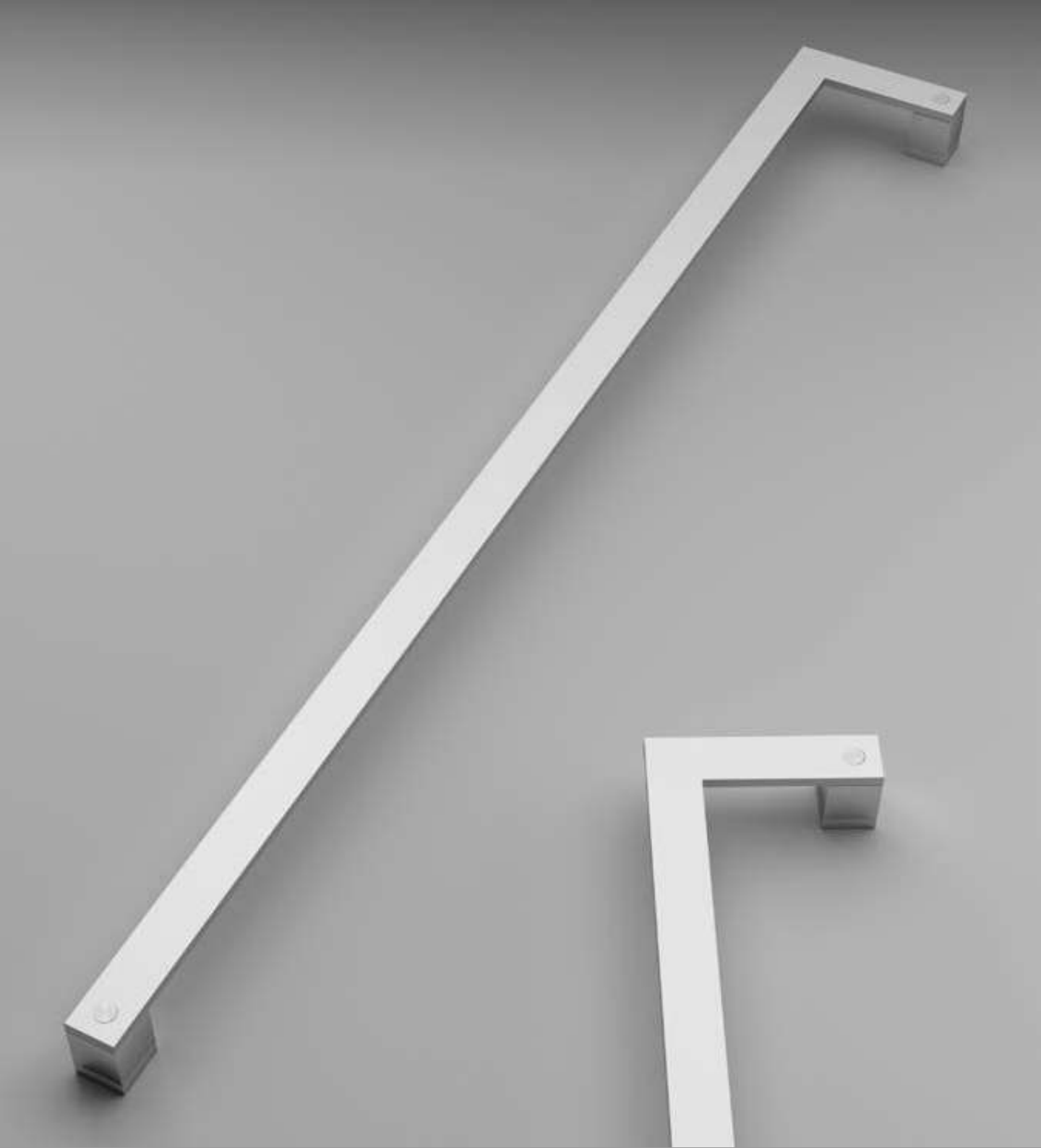

MANIGLIONE

ELLE

Design EFFEPI®

Un grande maniglione capace di definire con la propria caratterizzante presenza l'aspetto della porta. Una forma rigorosamente ispirata ai principi di un minimalismo formale dove la cura del dettaglio sostituisce ogni apparato decorativo. Realizzato in acciaio inox AISI 316.

A large push-bar capable of determining the appearance of the door with its characterising presence. A shape which is strictly inspired by the principles of a formal minimalism where the attention to details replaces any decorative device. Made of satin AISI 316 stainless steel.

FINITURA:



MIX CROMO
SATINATO/LUCIDO

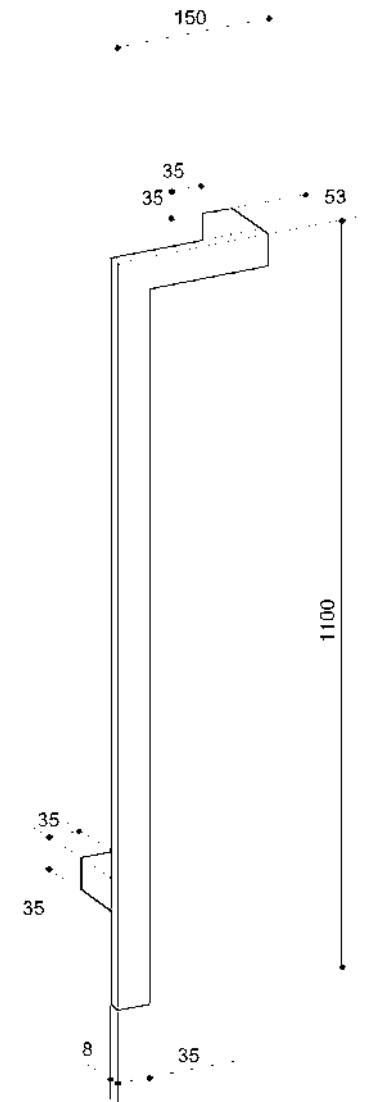

MANIGLIONE AD INCASSO

E-WAY

Design EFFEPI[®]
Maniglione ad incasso realizzato
nelle finitura lucido/satinato.

Flush pull knob made in polished
Chrome / mat chrome

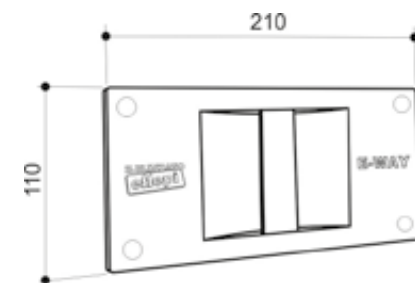

FINITURE:



MIX CROMO
LUCIDO/SATINATO

POMOLO

ROBOT 45
ROBOT 65

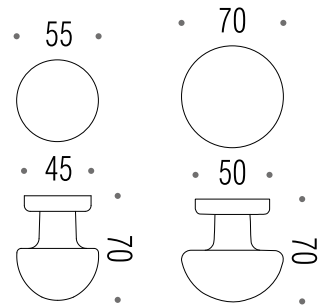

FINITURE:



OROMAT



OROPLUS



CROMAT



CROMO

POMOLO

SQUARE 35

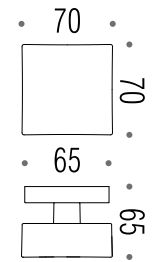

FINITURE:



CROMAT



CROMO





POMOLINO
ELLESSE



FINITURE:



CROMAT



CROMO



POMOLO
QUADRA

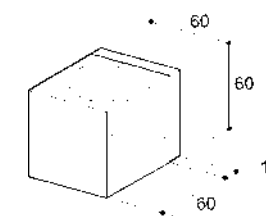

MIX CROMO
SATINATO/LUCIDO



POMOLINO
ROBOQUATTRO



FINITURE:



OROMAT



CROMAT



OROPLUS



CROMO



POMOLINO
QUADRA



FINITURA:



MIX CROMO
SATINATO/LUCIDO





DATI TECNICI

COORDINAMENTO DELLE MISURE

DEFINIZIONE DELLA MANO D'APERTURA DEFINITION OF OPENING HAND

PORTA A SPINGERE PUSHING DOOR

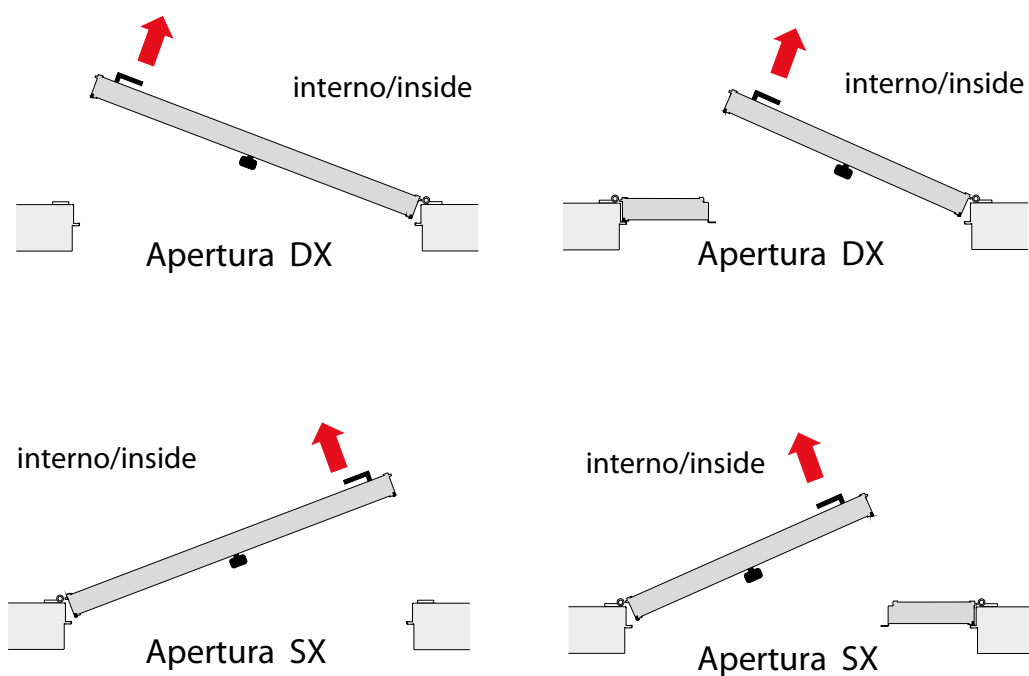

PORTA A TIRARE PULLING DOOR

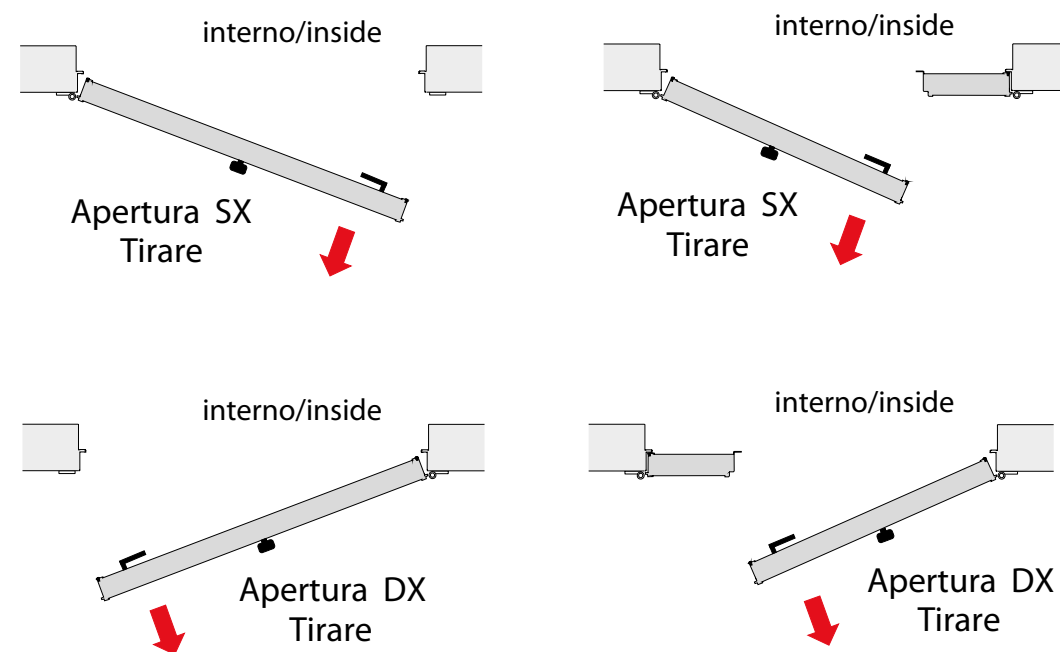

TIPOLOGIE DI CONTROTELAI KIND OF SUBFRAMES

**CONTROTELAIO
A GOLA**

SUBFRAME WITH
GROOVE TRACK

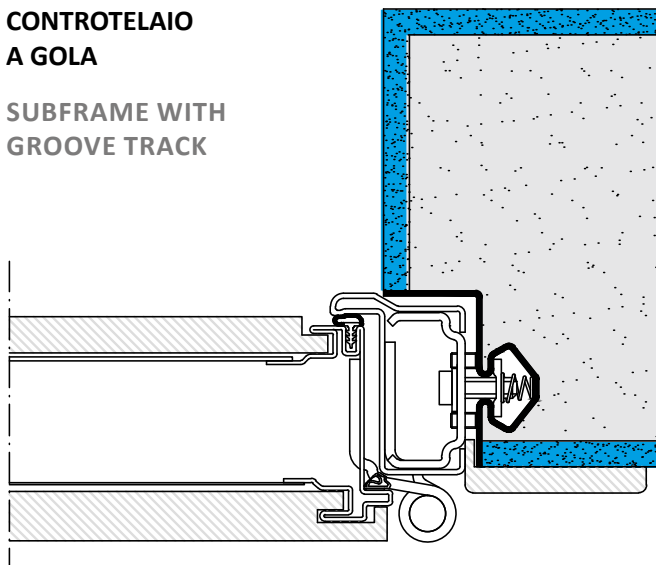

**CONTROTELAIO
A GOLA CON ALETTE**

SUBFRAME WITH
GROOVE TRACK

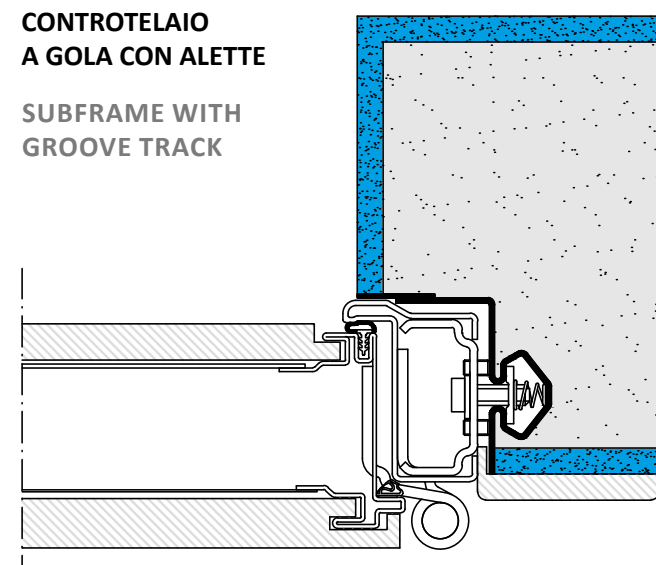

**CONTROTELAIO
A GABBIETTE**

SUBFRAME WITH
SMALL BOXES

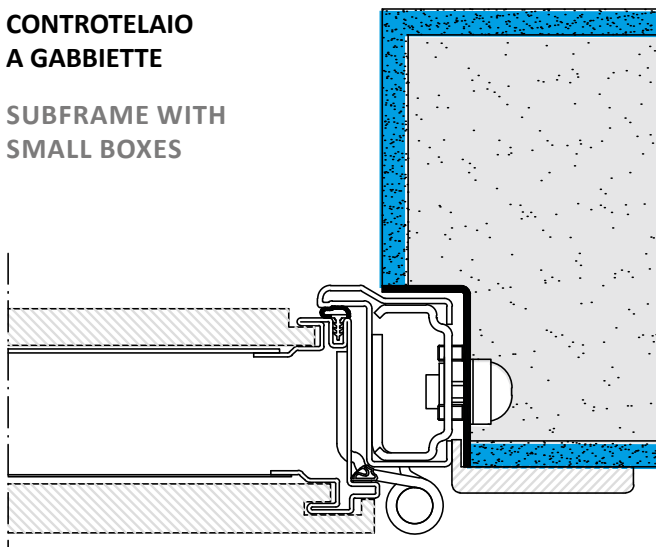

**CONTROTELAIO A
GABBIETTE CON ALETTE**

SUBFRAME WITH
SMALL BOXES

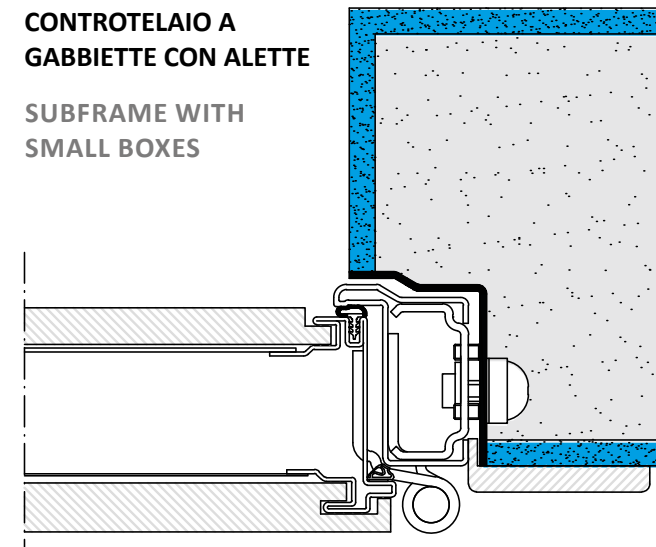

EFFEPI® si riserva di apportare qualsiasi modifica che ritenga utile al miglioramento del prodotto senza obbligo di preavviso.
 EFFEPI® reserves the right to carry out modifications which it considers useful for product improvement without prior warning.

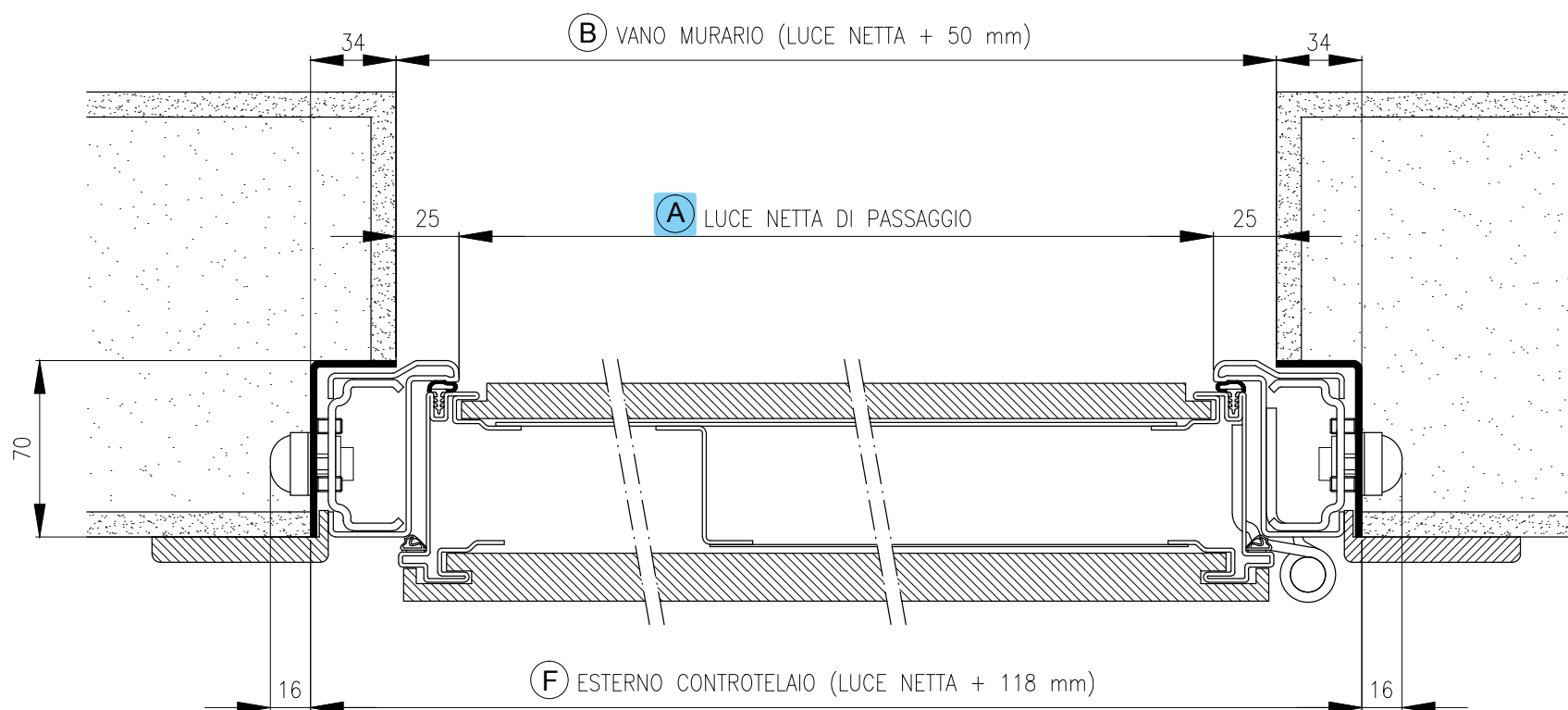

A (Luce netta)	B (A+50mm)	F (A+118mm)
800	850	918
850	900	968
900	950	1018

CONTROTELAIO A GABBIETTE SEZIONE VERTICALE SUBFRAME WITH SMALL BOXES VERTICAL SECTION

Configurazione pavimento complanare
Flush floor configuration

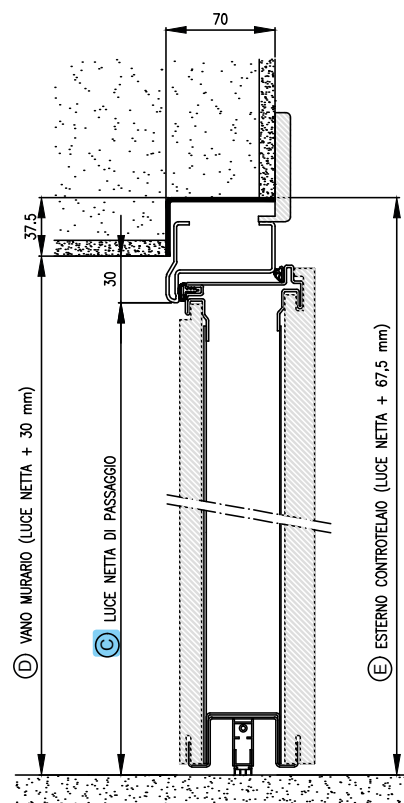

C (Luce netta)	D (C+30mm)	E (C+67,5mm)
2100	2130	2167,5

Configurazione con soglia di battuta
Configuration with sill rebate

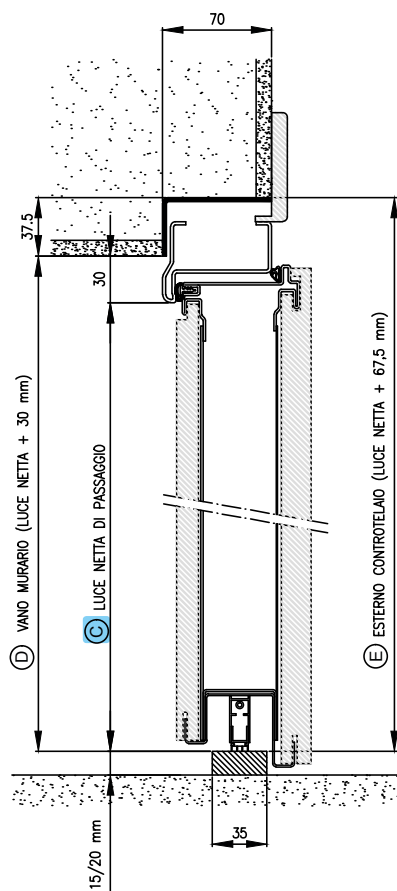

Configurazione con soglia tenuta aria-acqua-vento
Configuration with air-water-wind tightness sill

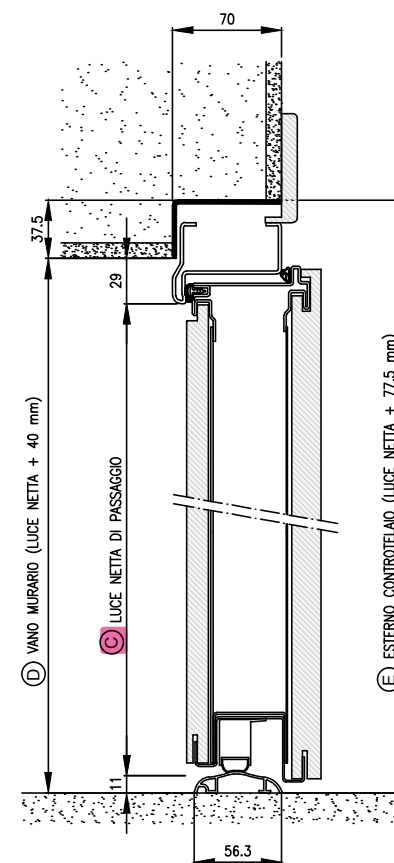

C (Luce netta)	D (C+30mm)	E (C+67,5mm)
2090	2130	2167,5



EFFEPI® si riserva di apportare qualsiasi modifica che ritenga utile al miglioramento del prodotto senza obbligo di preavviso.
 EFFEPI® reserves the right to carry out modifications which it considers useful for product improvement without prior warning.

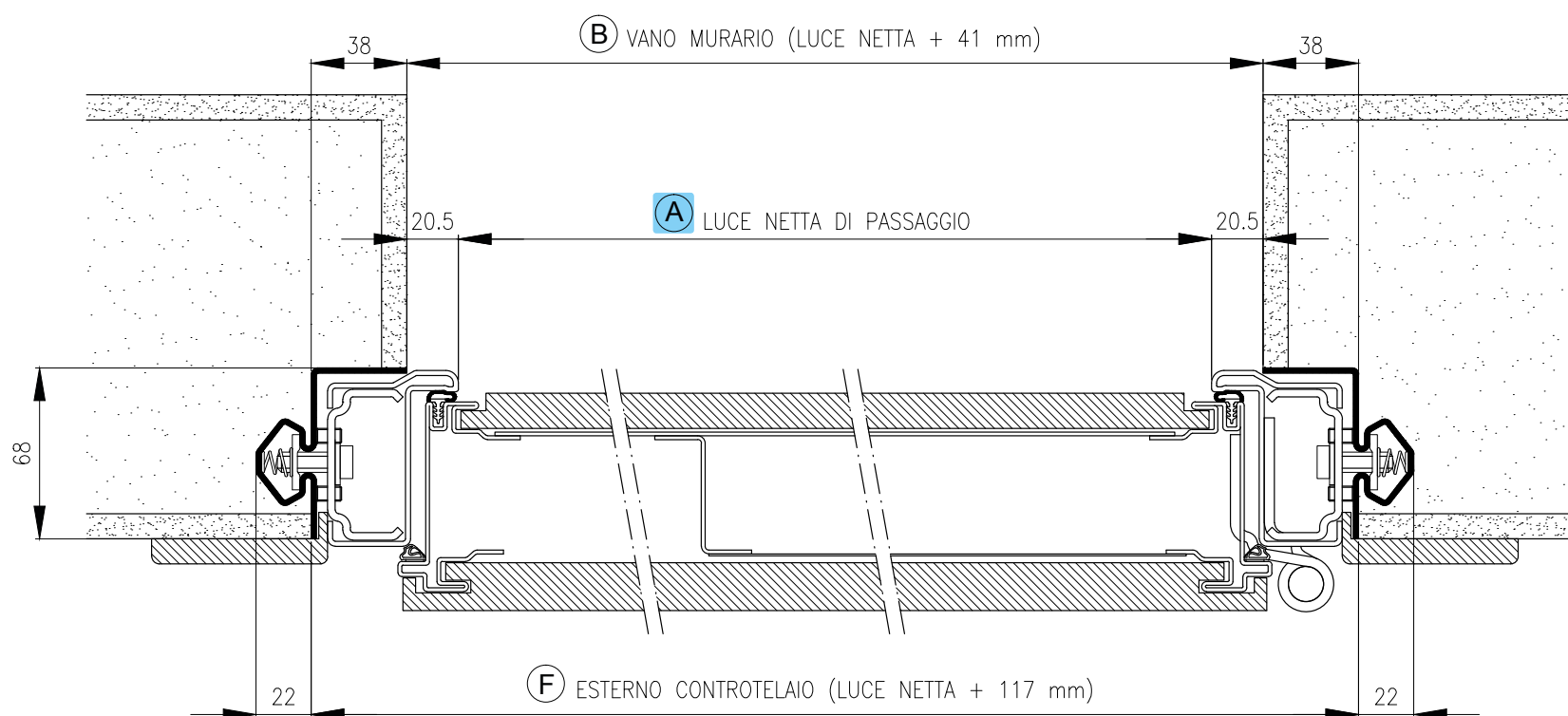

A (Luce netta)	B (A+41mm)	F (A+117mm)
800	841	917
850	891	967
900	941	1017

CONTROTELAIO A GOLA SEZIONE VERTICALE SUBFRAME WITH GROOVE TRACK VERTICAL SECTION

Configurazione pavimento complanare
Flush floor configuration

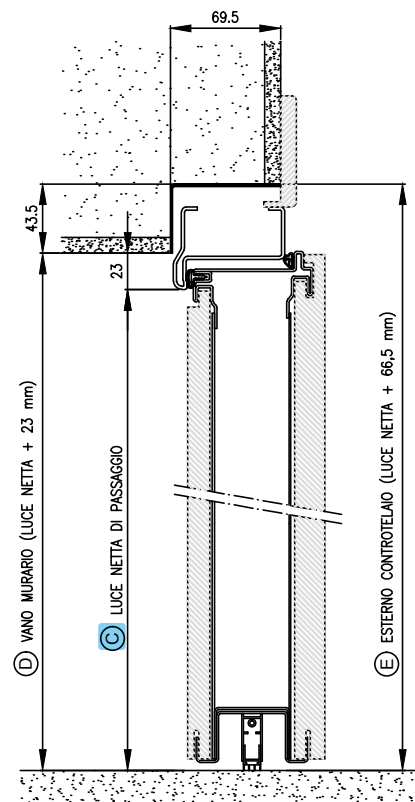

C (Luce netta)	D (C+23mm)	E (C+66,5mm)
2100	2123	2166,5

Configurazione con soglia di battuta
Configuration with sill rebate

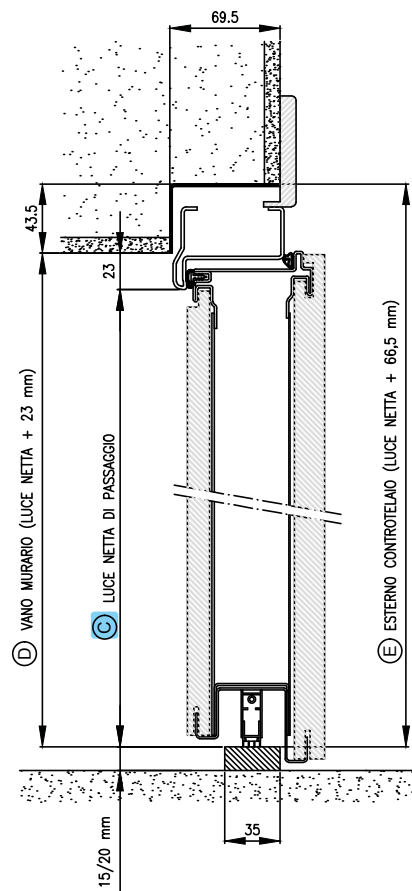

Configurazione con soglia tenuta aria-acqua-vento
Configuration with air-water-wind tightness sill

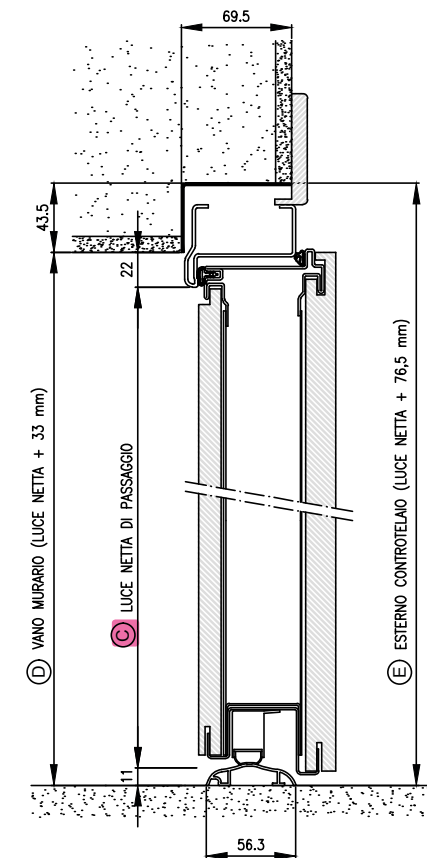

C (Luce netta)	D (C+30mm)	E (C+67,5mm)
2090	2123	2166,5

COORDINAMENTO DELLE MISURE
COORDINATION OF MEASURES

IMMENSA RASOMURO SEZIONE ORIZZONTALE
IMMENSA FLUSH FULL HORIZONTAL SECTION

EFFEPI® si riserva di apportare qualsiasi modifica che ritenga utile al miglioramento del prodotto senza obbligo di preavviso.
 EFFEPI® reserves the right to carry out modifications which it considers useful for product improvement without prior warning.

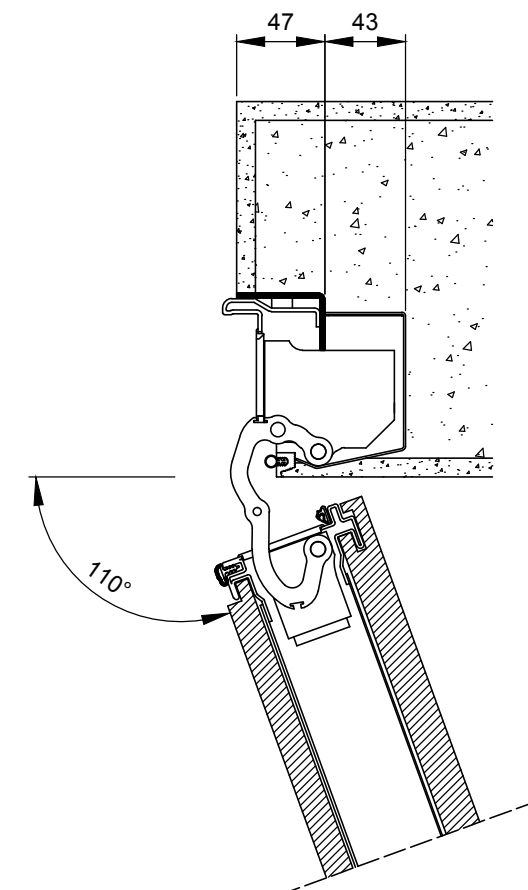
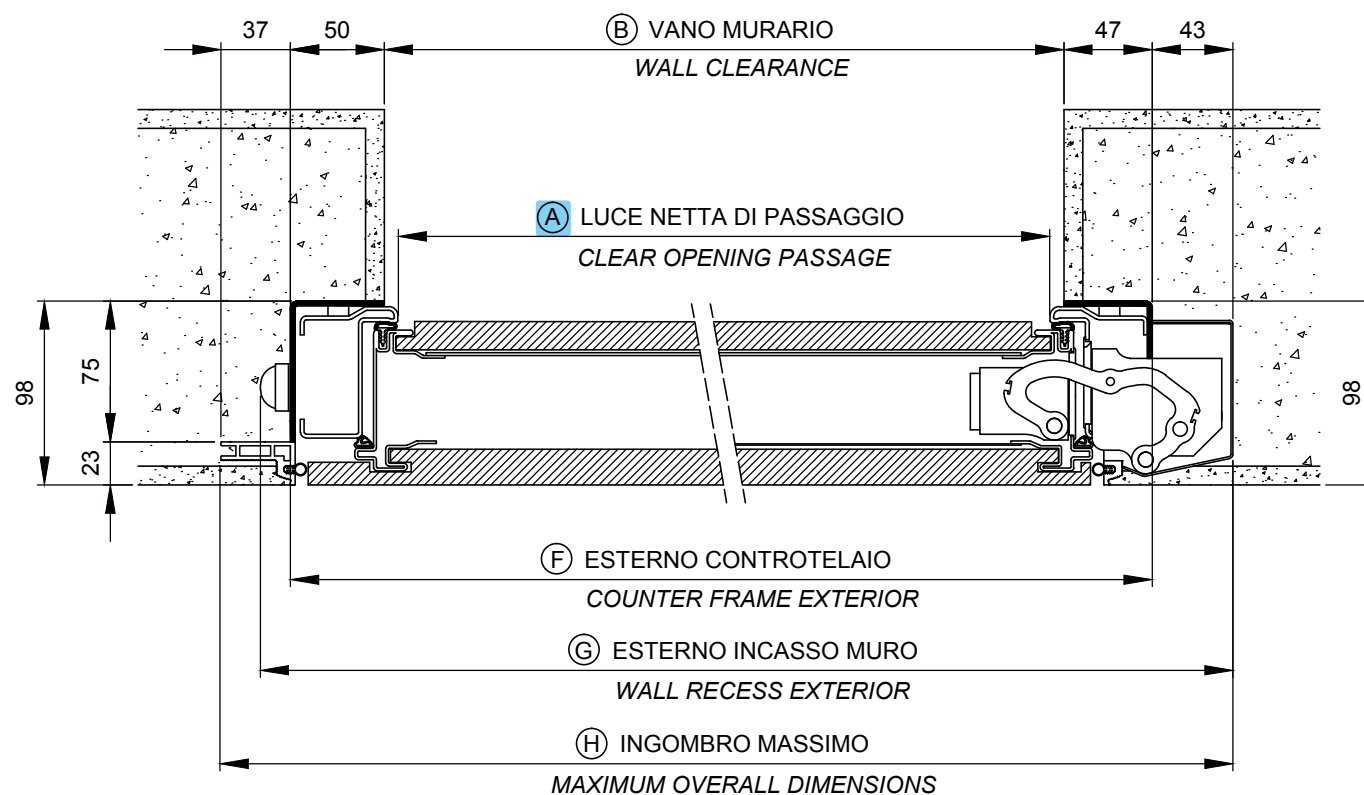

A	B	F	G	H
(Luce netta)	(A+15mm)	(A+112mm)	(A+171mm)	(A+193mm)
800	815	912	971	993
850	865	962	1021	1043
900	915	1012	1071	1093

IMMENZA RASOMURO SEZIONE VERTICALE IMMENZA FLUSH FULL VERTICAL SECTION

Configurazione pavimento complanare
Flush floor configuration

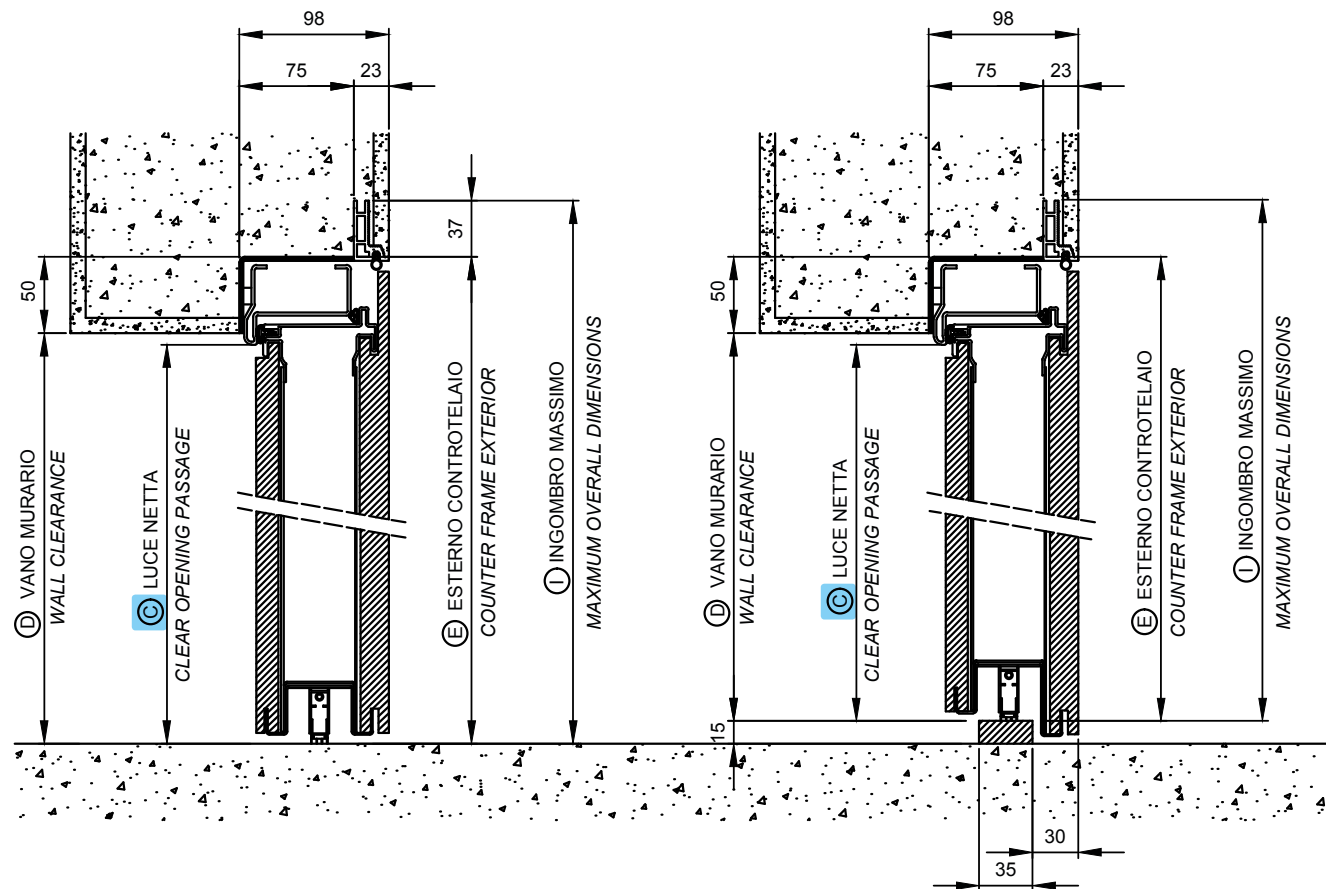

C (Luce netta)	D (C+7,5mm)	E (C+57,5mm)	I (C+95mm)
2100	2107,5	2157,5	2195

Configurazione con soglia di battuta
Configuration with sill rebate

Configurazione con soglia tenuta aria-acqua-vento
Configuration with air-water-wind tightness sill

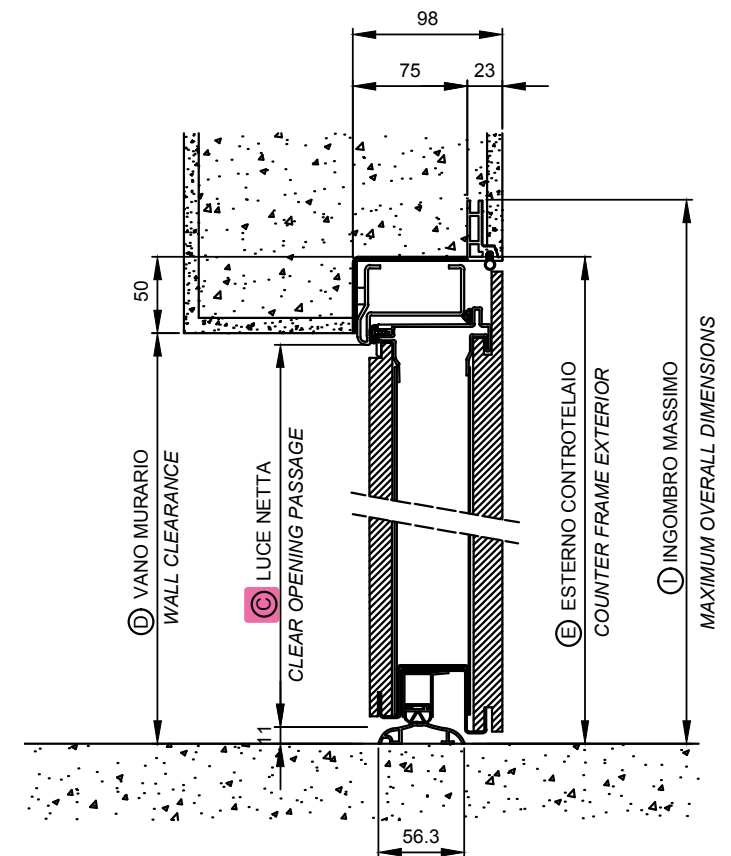

C (Luce netta)	D (C+17,5mm)	E (C+67,5mm)	I (C+105mm)
2190	2107,5	2157,5	2195

COORDINAMENTO DELLE MISURE
COORDINATION OF MEASURES

IMMENSA SEZIONE ORIZZONTALE
IMMENSE HORIZONTAL SECTION

EFFEPI® si riserva di apportare qualsiasi modifica che ritenga utile al miglioramento del prodotto senza obbligo di preavviso.
 EFFEPI® reserves the right to carry out modifications which it considers useful for product improvement without prior warning.

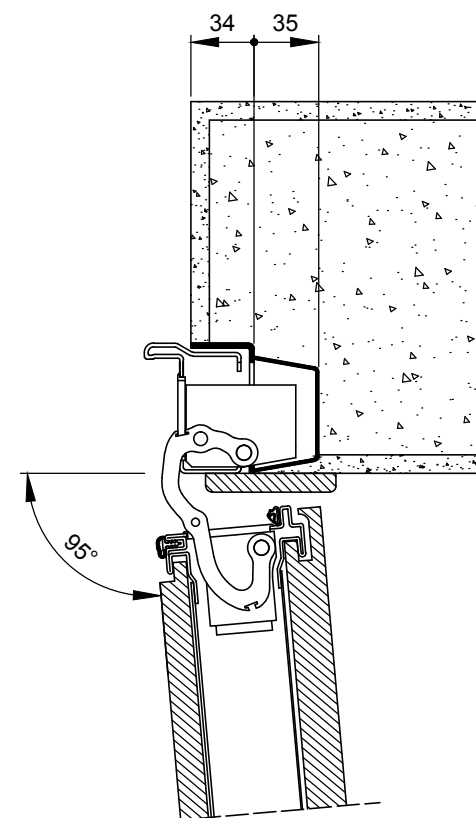
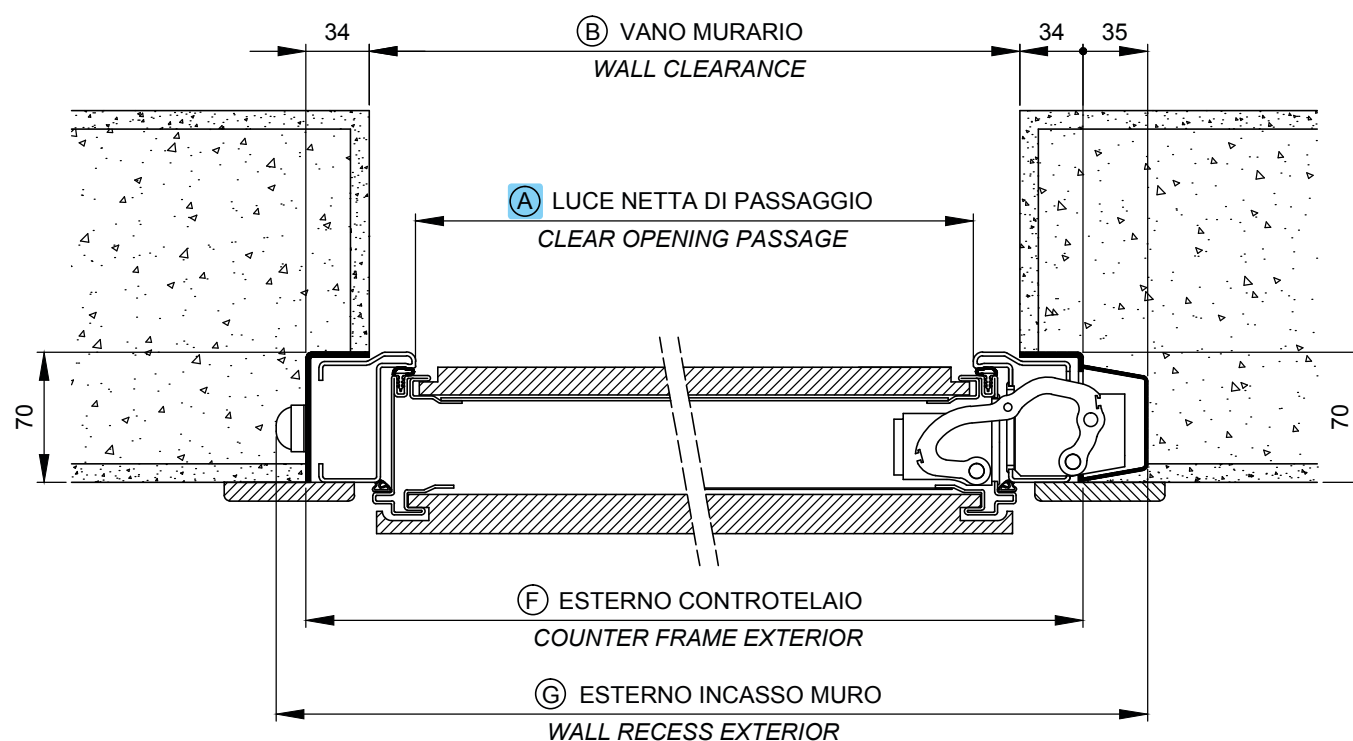

A (Luce netta)	B (A+50mm)	F (A+118mm)	G (A+169mm)
800	850	918	969
850	900	968	1019
900	950	1018	1069

IMMENZA SEZIONE VERTICALE IMMENZA VERTICAL SECTION

Configurazione pavimento complanare
Flush floor configuration

Configurazione con soglia di battuta
Configuration with sill rebate

Configurazione con soglia tenuta aria-acqua-vento
Configuration with air-water-wind tightness sill

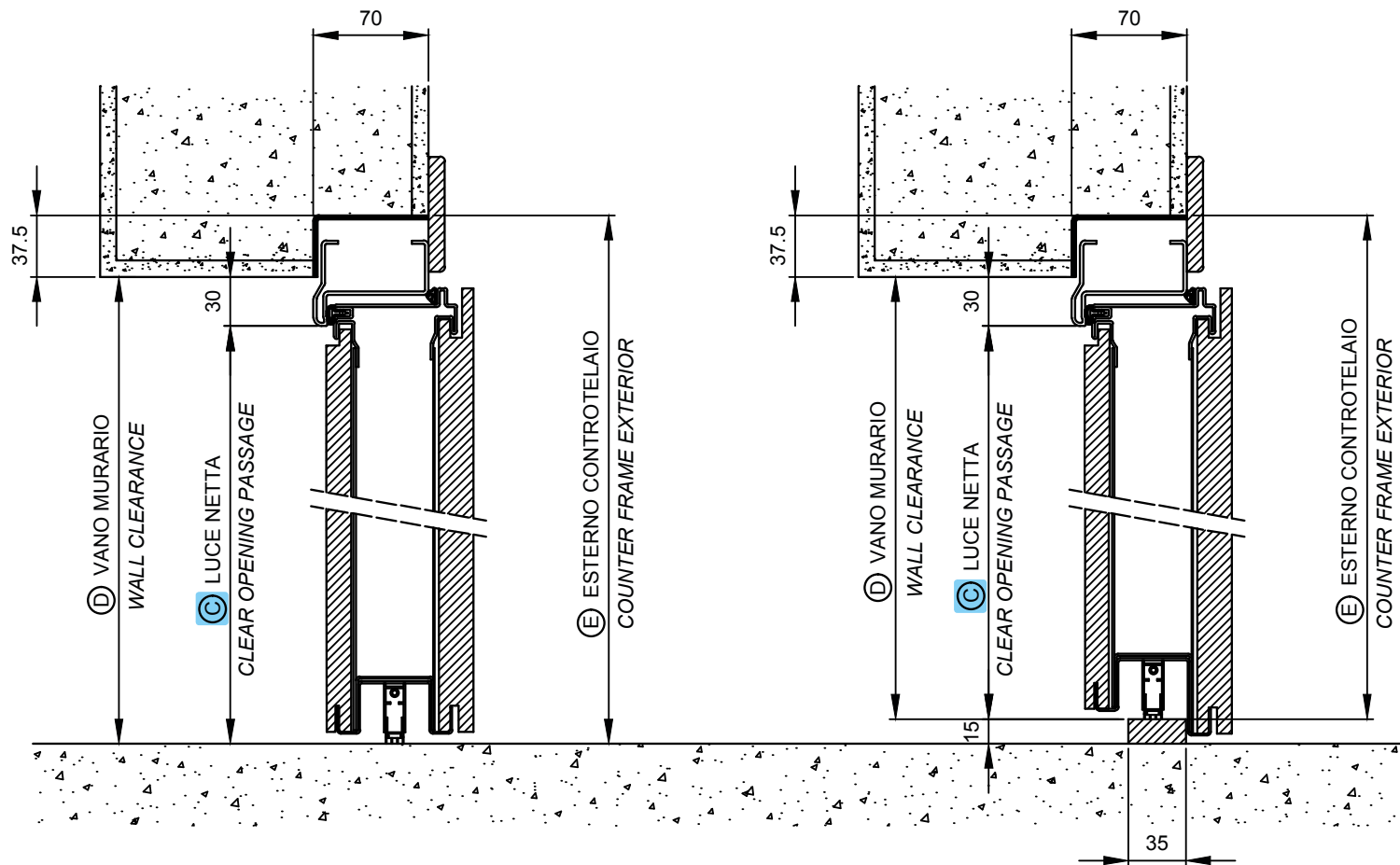

C (Luce netta)	D (C+30mm)	E (C+67,5mm)
2100	2130	2167,5

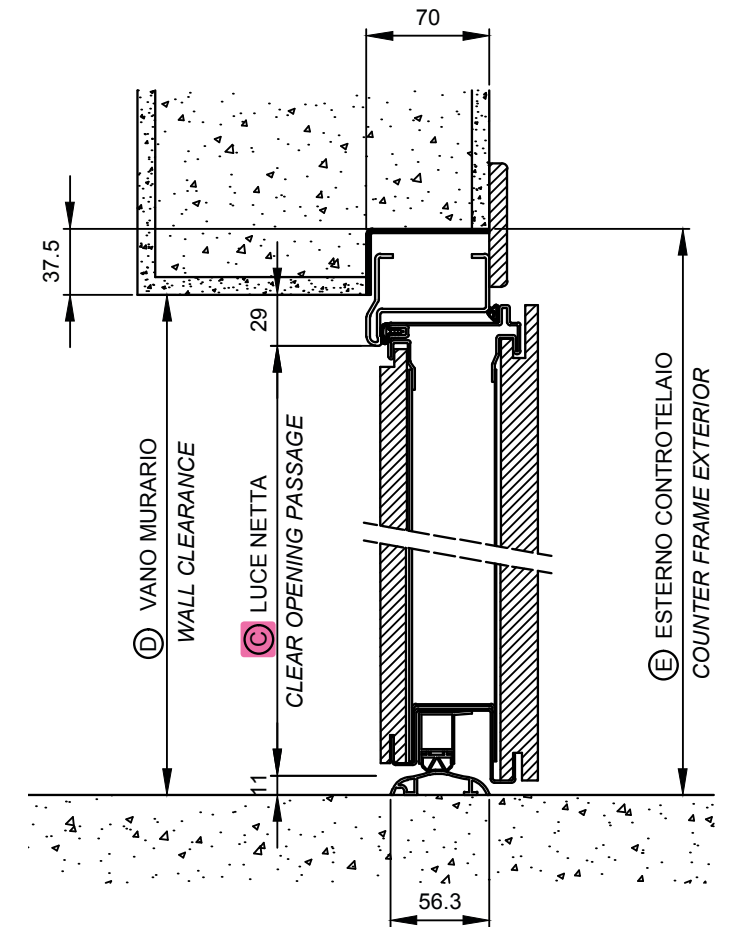

C (Luce netta)	D (C+40mm)	E (C+77,5mm)
2090	2130	2167,5



COORDINAMENTO DELLE MISURE
COORDINATION OF MEASURES

E-WAY VISTA FRONTALE
E-WAY FRONTAL VIEW

EFFEPI® si riserva di apportare qualsiasi modifica che ritenga utile al miglioramento del prodotto senza obbligo di preavviso.
 EFFEPI® reserves the right to carry out modifications which it considers useful for product improvement without prior warning.

TABELLA VISTA FRONTALE E SEZIONI ORIZZONTALI					
A	B	F	G	I	L
(Luce netta)	(A+18mm)	(A+120mm)	(Variabile)	(Variabile)	(Variabile)
900	918	1020	2368	1345	2358
1000	1018	1120	2500	1377	2490
1200	1218	1320	2770	1447	2760

N.B. Per la versione E-Way manuale le quote **G - I - L** vanno ridotte rispettivamente di 440mm.

TABELLA SEZIONI VERTICALI			
C	D	E	H
(Luce netta)	(C+26mm)	(C+301mm)	(C+41mm)
2100	2126	2401	2141
2200	2226	2501	2241
2350	2376	2651	2391

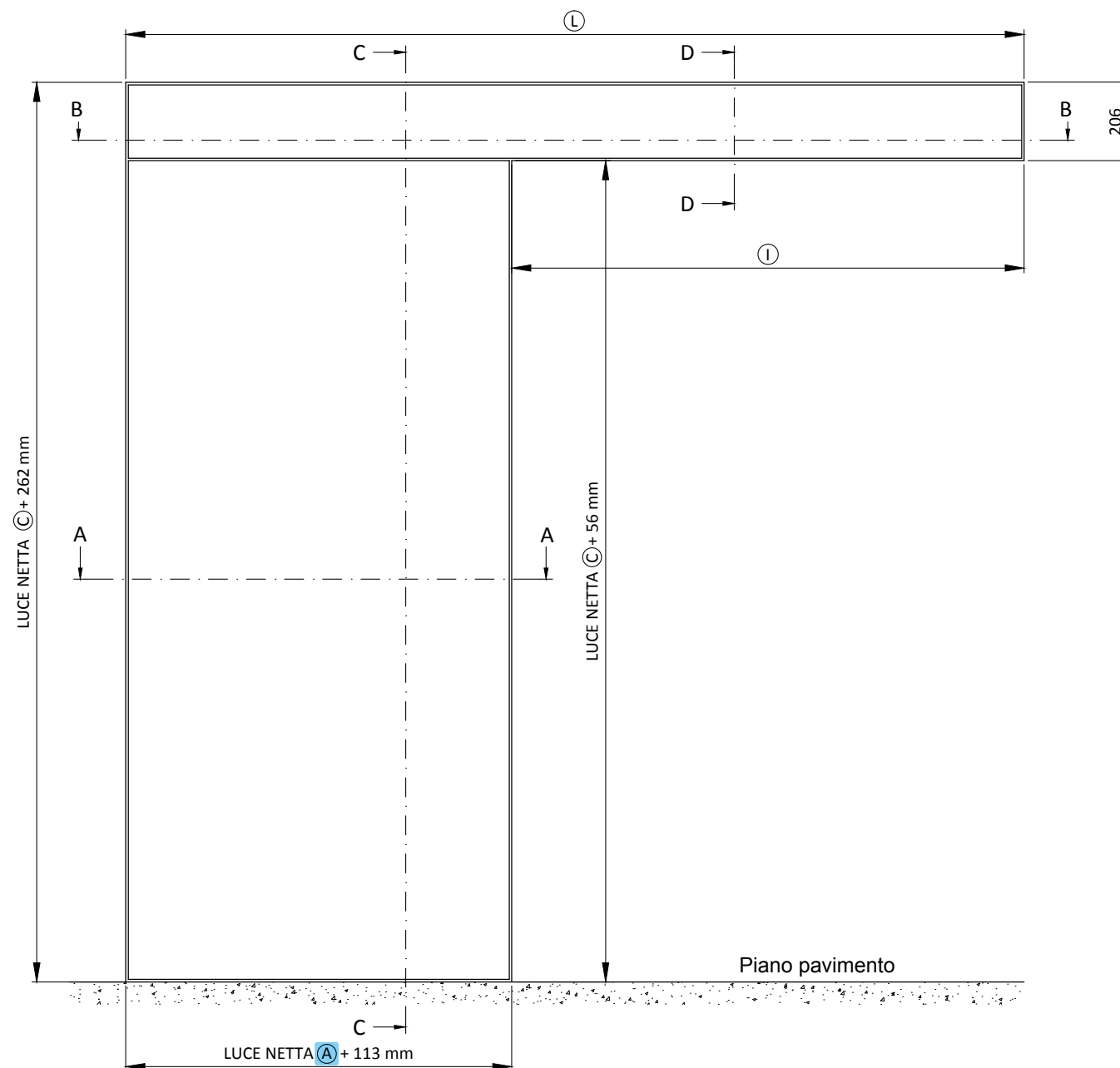

Sezione orizzontale A-A
Horizontal section

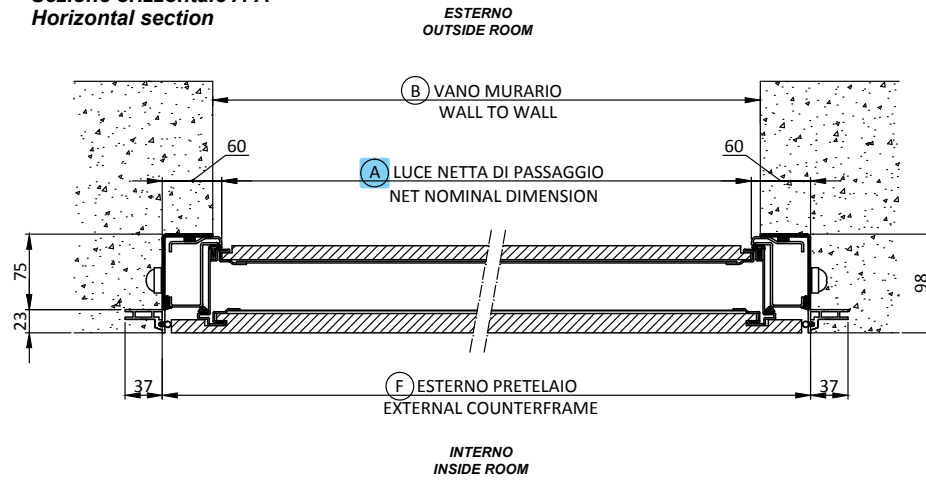

Sezione orizzontale B-B
Horizontal section

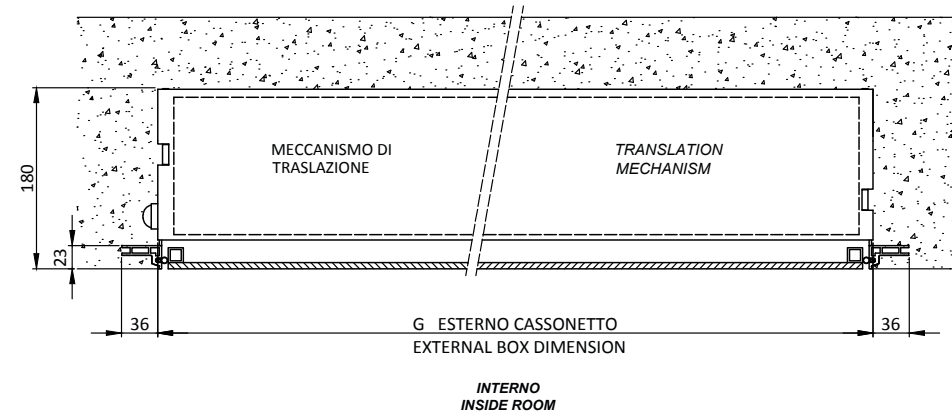

Sezione verticale C-C
Vertical section

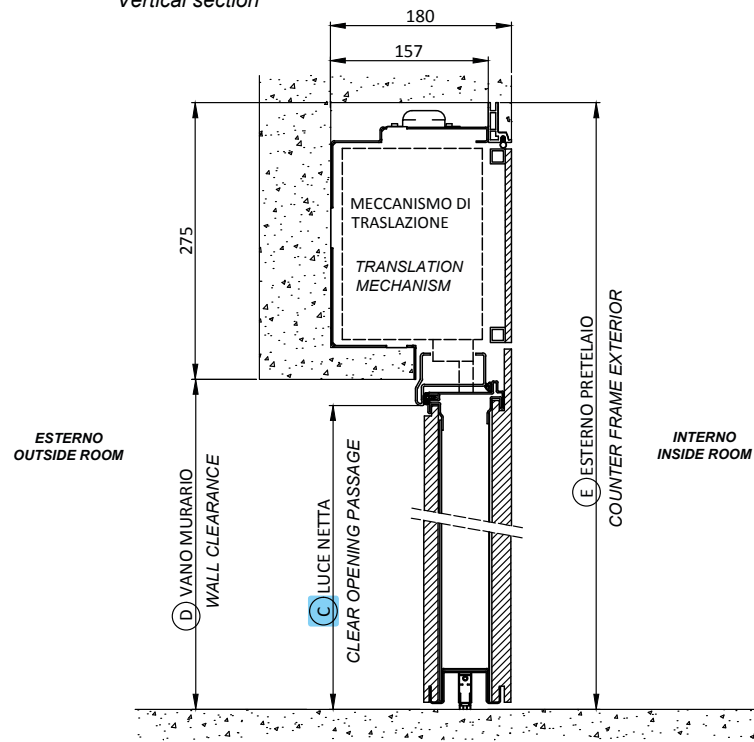

Sezione verticale D-D
Vertical section

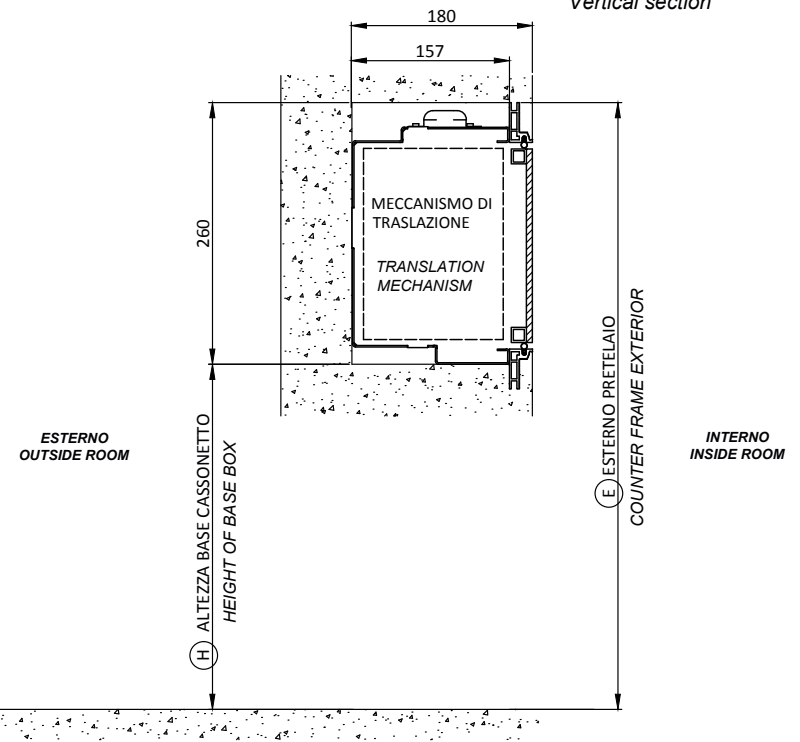



I MATERIALI



FINITURE PER RIVESTIMENTI ESTERNI

COLLECTIONS : LINEA - METALLI - TRATTO - PIETRE

Tutti i rivestimenti si possono realizzare e abbinare con le seguenti finiture:

legni / woods

WENGÈ
WENGÈ

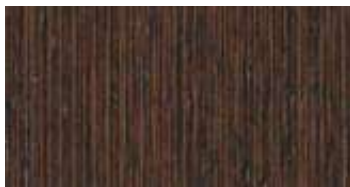

ROVERE SBIANCATO
BLEACHED OAK



ROVERE GRIGIO
GREY OAK

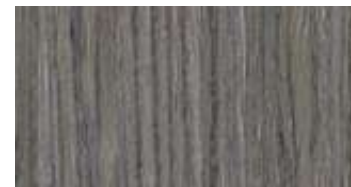

CILIEGIO
CHERRY



NOCE NAZIONALE
ITALIAN WALNUT



TEAK
TEAK



ZEBRANO
ZEBRAWOOD



EBANO
EBONY



NOCE CANALETTO
WALNUT



ROVERE MOKA
MOKA OAK

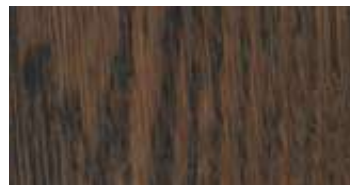

ROVERE CENERE
ASHEN OAK



metalli / metals

ACCIAIO INOX
STAINLESS STEEL



ACCIAIO CORTEN
CORTEN STEEL



pietre / stones

PIETRA BLACK
BLACK STONE



PIETRA SAHARA
SAHARA STONE



PIETRA MULTICOLOR
MULTICOLOR STONE



PIETRA SILVER SHINE
SILVER SHINE STONE



laccati / laquered

LACCATO TORTORA
DOVE-GREY LAQUERED

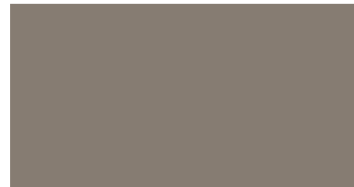

LACCATO GRIGIO PLATINO
PLATINUM GREY LAQUERED



LACCATO VERDE TENUE
YELLOW GREEN LAQUERED

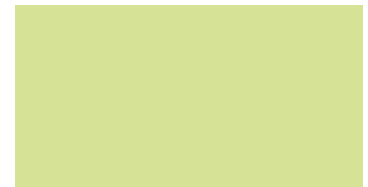

LACCATO MELANZANA
EGGPLANT LAQUERED



LACCATO LAVANDA
LAVENDER LAQUERED

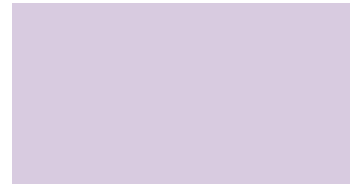

LACCATO CREMA
CREAM LAQUERED

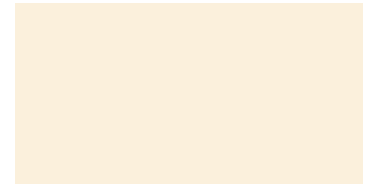

LACCATO TABACCO
TOBACCO LAQUERED



LACCATO ECRÙ
ECRÙ LAQUERED



FINITURE PER RIVESTIMENTI ESTERNI

COLLECTIONS : TERRE - CERAMIC

Tutti i rivestimenti si possono realizzare con le seguenti finiture:

terre / lands

BIOMALTA NERO
BLACK BIOMALTA



BIOMALTA CASTAGNA
CHESTNUT BIOMALTA



BIOMALTA ARDESIA
BIOMALTA SLATE



BIOMALTA ARENARIA
SANDSTONE BIOMALTA



BIOMALTA GRIGIO
GREY BIOMALTA

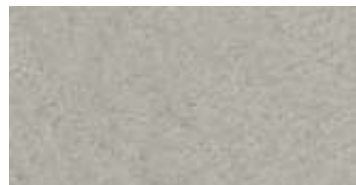

BIOMALTA BIANCO
WHITE BIOMALTA

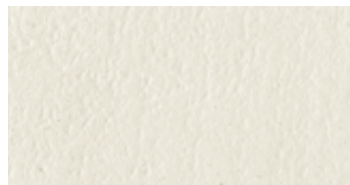

ceramic

ELEGANCE VIA CONDOTTI



ELEGANCE VIA TORNABUONI



ELEGANCE VIA FARINI



EXEDRA PULPIS LUX



EXEDRA AMADEUS LUX



EXEDRA CALACATTA LUX



OVER ROAD



OVER OFFICE

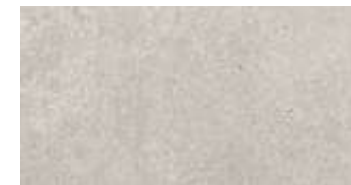

FINITURE PER RIVESTIMENTI ESTERNI

COLLECTION : PLANK - MASSELLI

Tutti i rivestimenti si possono realizzare con le seguenti finiture:

plank

NATURA
NATURE



GRIGIO SABBIA
GREY SAND



masselli / solid wood

ROVERE
OAK



ROVERE SPAZZOLATO
BRUSHED OAK



ROVERE DECAPATO
BLEACHED OAK

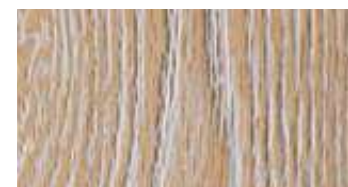

IROKO
IROKO



DOUGLAS
DOUGLAS



PINO
PINE



CASTAGNO
CHESTNUT



FINITURE PER RIVESTIMENTI ESTERNI

COLLECTION : PANTOGRAFATI

Tutti i rivestimenti si possono realizzare con le seguenti finiture:

pantografati

RAL 9010

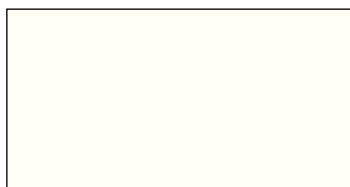

RAL 1013



RAL 6005



OKOUME TINTO NOCE MEDIO
WALNUT PAINTED OKOUME



OKOUME TINTO ROVERE
OAK PAINTED OKOUME



OKOUME TINTO CILIEGIO
CHERRY PAINTED OKOUME

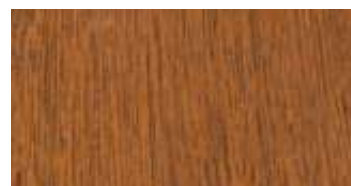

WENGÈ
WENGÈ



ROVERE SBIANCATO
BLEACHED OAK



FINITURE PER RIVESTIMENTI ESTERNI

COLLECTION : ALLUMINIO

Tutti i rivestimenti si possono realizzare con le seguenti finiture:

alluminio

RAL 9010



RAL 1013



RAL 6005



RAL 8017

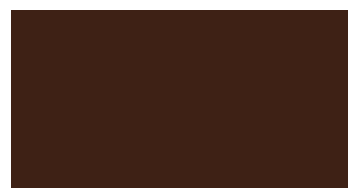

RENOLIT CILIEGIO 2178001



RENOLIT ROVERE 2052090



RENOLIT NOCE FIAMMATO
2178008



RENOLIT VERDE 612505



CILIEGIO 317/70 R

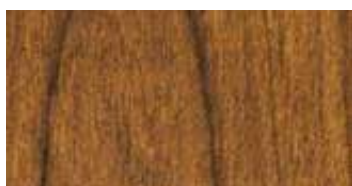

DOUGLAS 335/80 R



ROVERE P 80 R



NOCE 363/70

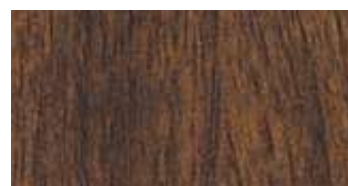

FINITURE PER RIVESTIMENTI ESTERNI

COLLECTION : PVC

Tutti i rivestimenti si possono realizzare con le seguenti finiture:

PVC

BIANCO PORO 809
WHITE 809 COLOUR



BETULLA 031
BIRCH 031 COLOUR



CHERRY AMARETTO 043



QUERCIA MOCCA 048
OAK MOCCA 048 COLOUR

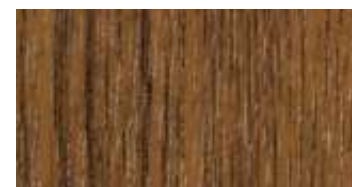

ALLUMINIO 001



BEIGE 015



NOCE KOLONIAL 062
WALNUT KOLONIAL 062 COLOUR



NOCE SORRENTO 042
WALNUT SORRENTO 042 COLOUR



QUERCIA TERRA 035
OAK TERRA 035 COLOUR



PLATINO 004
PLATINUM 004 COLOUR



SHEFFIELD OAK 081



NOCE AMARETTO 058
WALNUT AMARETTO 058 COLOUR



QUERCIA KOLONIAL 036
OAK KOLONIAL 036 COLOUR



METALLIC WOOD MOCCA 011

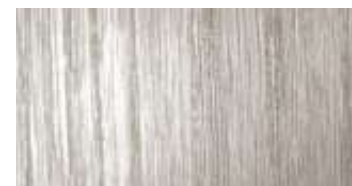



FINITURE PER RIVESTIMENTI INTERNI

COLLECTIONS : LINEA - METALLI - TRATTO - INTARSI - PREZIOSI - RILIEVO - RIFLESSI

Tutti i rivestimenti si possono realizzare e abbinare con le seguenti finiture:

legni / woods

WENGÈ
WENGÈ



ROVERE SBIANCATO
BLEACHED OAK



ROVERE GRIGIO
GREY OAK



CILIEGIO
CHERRY



NOCE NAZIONALE
ITALIAN WALNUT



TEAK
TEAK



ZEBRANO
ZEBRAWOOD



FRASSINO BIANCO
WHITE PAINTED ASH



FRASSINO ECRÙ
ECRÙ PAINTED ASH



EBANO
EBONY



NOCE CANALETTO
WALNUT



ROVERE MOKA
MOKA OAK



ROVERE CENERE
ASHEN OAK



preziosi / precious

ROVERE SBIANCATO CON CRISTALLI VERDI
BLEACHED OAK WITH GREEN GLASS
INSERTS



WENGHÈ CON CRISTALLI BIANCHI
WENGE WITH WHITE GLASS INSERTS



WENGHÈ CON CRISTALLI BLU
WENGE WITH BLUE GLASS INSERTS



LACCATO LAVANDA CON CRISTALLI ROSA
LAVENDER LACQUERED WITH PINK GLASS
INSERTS



laccati / laquered

LACCATO TORTORA
DOVE-GREY LAQUERED

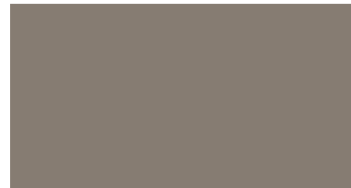

LACCATO GRIGIO PLATINO
PLATINUM GREY LAQUERED

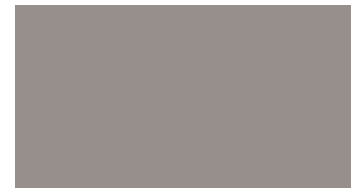

LACCATO VERDE TENUE
YELLOW GREEN LAQUERED

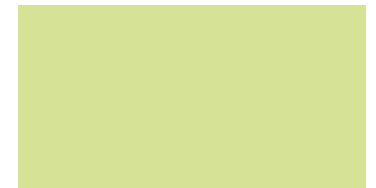

LACCATO MELANZANA
EGGPLANT LAQUERED



LACCATO LAVANDA
LAVENDER LAQUERED

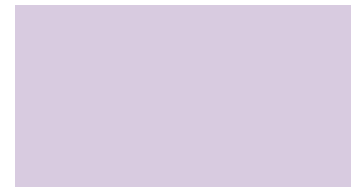

LACCATO CREMA
CREAM LAQUERED

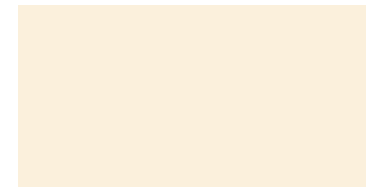

LACCATO TABACCO
TOBACCO LAQUERED



LACCATO ECRÙ
ECRÙ LAQUERED



FINITURE PER RIVESTIMENTI INTERNI

COLLECTION : TERRE

Tutti i rivestimenti si possono realizzare e abbinare con le seguenti finiture:

terre / lands

BIOMALTA NERO
BLACK BIOMALTA



BIOMALTA CASTAGNA
CHESTNUT BIOMALTA



CEMENTO GRIGIO TEMPESTA
GREY STORM CEMENT



CEMENTO GRIGIO ACCIAIO
STEEL GREY CEMENT



BIOMALTA ARDESIA
BIOMALTA SLATE



BIOMALTA ARENARIA
SANDSTONE BIOMALTA

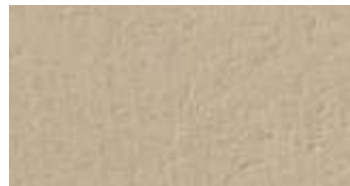

CEMENTO CREMA
CREAM CEMENT



CEMENTO BOSCO
WOODS CEMENT



BIOMALTA GRIGIO
GREY BIOMALTA

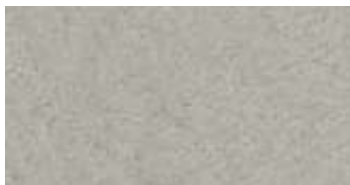

BIOMALTA BIANCO
WHITE BIOMALTA

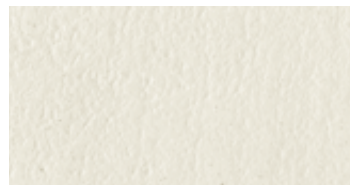

CEMENTO BIANCO NEBBIA
WHITE FOG CEMENT

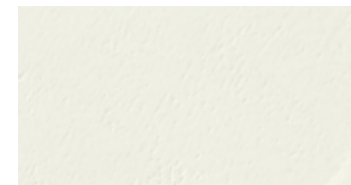

in abbinamento con i seguenti decori

FRASSINO BIANCO
WHITE PAINTED ASH



ROVERE SBIANCATO
BLEACHED OAK



ROVERE GRIGIO
GREY OAK

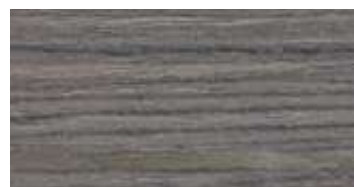

NOCE CANALETTO
WALNUT



ROVERE CENERE
ASHEN OAK



EBANO
EBONY



FINITURE PER RIVESTIMENTI INTERNI

COLLECTION : WALLPAPER

Tutti i rivestimenti si possono realizzare con le seguenti finiture:

wallpaper

CONCRETE



TORINO



E2R2



PRUNUS



DIANTHUS 1



DIANTHUS 2



FINITURE PER RIVESTIMENTI INTERNI

COLLECTION : PIANA ORIZZONTALE

Tutti i rivestimenti si possono realizzare con le seguenti finiture:

piana orizzontale

WENGÈ
WENGÈ



ROVERE SBIANCATO
BLEACHED OAK



ROVERE GRIGIO
GREY OAK



CILIEGIO
CHERRY



NOCE NAZIONALE
ITALIAN WALNUT



TEAK
TEAK



ZEBRANO
ZEBRAWOOD



FRASSINO BIANCO
WHITE PAINTED ASH



FRASSINO ECRÙ
ECRÙ PAINTED ASH



EBANO
EBONY



NOCE CANALETTO
WALNUT



ROVERE MOKA
MOKA OAK



ROVERE CENERE
ASHEN OAK



FINITURE PER RIVESTIMENTI INTERNI

COLLECTIONS : PIANA VERTICALE - LACCATI RAL - NEWOOD

Tutti i rivestimenti si possono realizzare con le seguenti finiture:

piana verticale

NOCE NAZIONALE
ITALIAN WALNUT



TANGANICA NATURALE
NATURAL TANGANIKA



ROVERE
ROVERE



FRASSINO
ASH



ROVERE SBIANCATO
BLEACHED OAK



MOGANO CHIARO
LIGHT MAHOAGANY



TANGANICA CHIARO
LIGHT TANGANIKA



NOCE MANSONIA
MANSONIAN WALNUT



TEAK
TEAK

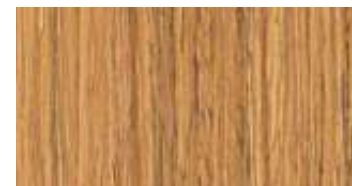

DOUGLAS
DOUGLAS



MOGANO SCURO
DARK MAHOAGANY



TANGANICA SCURO
DARK TANGANIKA



CILIEGIO
CHERRY



WENGÈ
WENGÈ

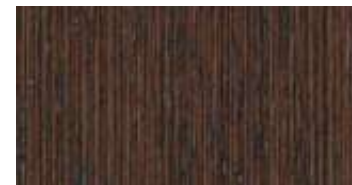

CASTAGNO
CHESTNUT



newood

BIANCO EFFEPI
WHITE EFFEPI

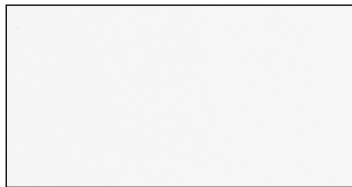

T3



R1



N1



C1



LARICE BIANCO
WHITE LARCH



WENGÈ
WENGÈ



ROVERE JOPLIN
JOPLIN OAK



ROVERE SBIANCATO
BLEACHED OAK



laccati RAL

Tutta la gamma lucido e opaco
The entire range



CAFFÈ
COFFEE

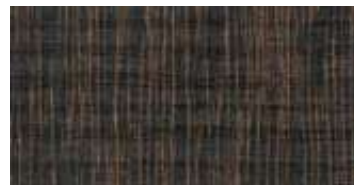

TERRA
LAND



SABBIA
SAND



NOTE NOTES

Effepi® si riserva di apportare modifiche o migliorie costruttive ai prodotti presenti nel catalogo senza preavviso ed in qualsiasi momento. Le immagini, i disegni e le tonalità delle essenze riportate hanno valore puramente indicativo e non impegnativo.

Effepi® reserves the right to modify the products in the catalogue as well as to make technical changes without any advance communication.

Pictures, graphics and the colours of the different wood types in the catalogue are merely indicative.

Le porte blindate Effepi® sono interamente prodotte in Italia, costruite con le più moderne tecniche di produzione e con materiali di primissima qualità. Si riconoscono, oltre che per la bellezza e la solidità, da un marchio fissato sul telaio.

Per ulteriori informazioni e consigli relativi all'uso e manutenzione di questo prodotto vi consigliamo di consultare il nostro sito

www.effepisecuritydoors.com

The Effepi® armoured doors are made in Italy and they are built using the most modern production techniques and first quality materials. They can be recognised, besides for their beauty and solidity, by the trademark on the frame.

For further information and advice concerning use and maintenance of this product, we recommend that you consult our web site at

www.effepisecuritydoors.com

CONTATTI CONTACTS

Blindato Effepi S.r.l.

Tel. +39 0541.957278

Tel. +39 0541 957374

Fax +39 0541.953444

info@effepisecuritydoors.com

www.effepisecuritydoors.com

Ufficio commerciale Marketing office

commerciale@effepisecuritydoors.com

Ufficio amministrativo Administration office

amministrazione@effepisecuritydoors.com

Ufficio tecnico Technical office

tecnico@effepisecuritydoors.com

Ufficio estero Export office

estero@effepisecuritydoors.com



CREDITS



AD & graphic project
www.3dstudiobartolini.com

Fotografia
Studio Candiotti 1925, Rimini

Immagini concesse su licenza di shutterstock.com
(pagine 4-19-79-81-86)

Stampa
Pazzini Stampatore Editore srl

"kerlite é un marchio registrato di Cotto d'Este"



effepi
SECURITY DOORS 

BLINDATO EFFEPI s.r.l.

Via Malpasso n. 1735/B

47842 San Giovanni in Marignano (RN) ITALY

tel. +39 0541.957278

tel. +39 0541.957374

fax +39 0541.953444

www.ffepeisecuritydoors.com

info@ffepeisecuritydoors.com

